

# PRIMAL

STRENGTH

# PRIMAL STRENGTH

## WHO WE ARE.

Primal Strength represents aspirational, British-designed, fitness equipment aimed commercial fitness facilities. We present a cutting edge, design-focussed strength brand, dedicated to delivering the highest specification of category-leading equipment.

Primal Strength has two core ranges; the Commercial series and the Monster series. Our Commercial series has been designed to offer the best value for money whilst ensuring that the product has optimum functionality. This range includes our dual function machines which offer a space saving option for many facilities, our smith machine and our rubber hex dumbbells. Within this range we offer a selection of folding racks and storage solutions to suit even the most compact of studios whilst never compromising on quality.

The Monster Series offers the highest level of design and has been extensively tested to ensure its suitability in large high traffic facilities and performance centres. The range offers performance racks and benches, factory welded ISO machines and premium EPDM topped flooring solutions. We also offer an extensive range of specialist bars, weights and dumbbells to cater to every possible end user; from our calibrated steel plates and bumpers to our customisable steel dumbbells, the Monster series is unrivalled in both quality and function.

The brand employs several premium textures for our equipment in order to deliver the highest quality durability and aesthetics for our customers. Specifically, we use brushed aluminium, matte paint finishes, chrome and ionised metal accessories, all finished using stealth black bolts. The upholstery for our premium benches is of the highest quality material and is subtly branded with the Primal Strength logo or we can custom wrap our benches with your logo/brand.



PG 93



PG 15



PG 89

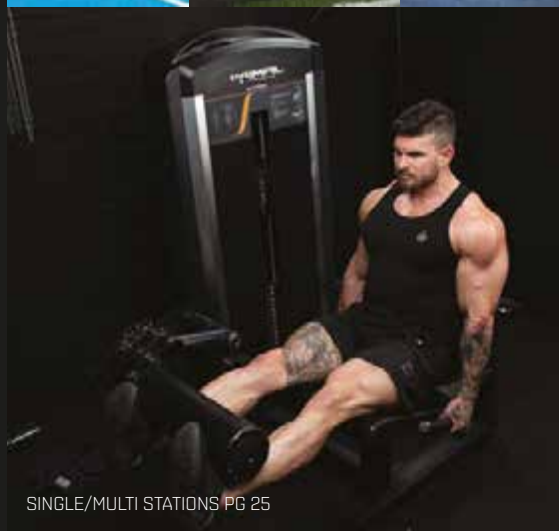

SINGLE/MULTI STATIONS PG 25



FUNCTIONAL ACCESORIES PG 66



RACKS PG 2

DUMBBELLS PG 60

## CONTENTS.

RACKS	2
PLATE LOADED MACHINES	15
SINGLE/MULTI STATION MACHINES	25
PLATFORMS	36
BENCHES	40
OLYMPIC BARS & COLLARS	48
OLYMPIC DISCS & OLYMPIC BUMPERS	54
FIXED DUMBBELLS & BARBELLS	60
FUNCTIONAL ACCESSORIES	66
CABLE AND BARBELL ATTACHMENTS	84
STORAGE SOLUTIONS	89
FLOORING AND ASTRO TRACKS	93
CUSTOM	98
CV	100
3D GYM DESIGN	120
CASE STUDIES	122
GLOBALLY TRUSTED BRAND	124
PRODUCT LIST	126

# RACKS

Primal Strength offer an extensive range includes our best selling V3 Half Rack with Westside style spacing and swivel chin-up handles, our Monster Series Performance Rack with 50mm integrated platform and our all-in-one Monster Rack System with built in Smith Machine, Dual Pulley, Leg Press and Lat Pull Down.

The range also includes several Folding Racks to save space, Safety Racks for Performance Centres and Commercial Smith Machines.

Primal Strength Rack's are covered with a lifetime frame warranty ensuring you buy once for life.

RACKS

## MONSTER SERIES COMMERCIAL PERFORMANCE RACK

- > Industry Leading, 1000kg Rated, Commercial Power Rack
- > Overbuilt 270cm, 75mm Box Steel With 2cm Spacing, 37mm Nut & Bolt Heads
- > Premium Rubber Sandwich J-Hooks, Safeties, Front Safeties, Safety Straps
- > Landmine Row, Vertical Bar Holder, 8 Olympic Disc Storage Pins
- > 10 Grip Front Chin Frame, Rear Adjustable/Lockable Angle Chin Handles
- > Plyo Box Rubber Centre Frame, Multiple Leather Rollers, Adjustable Band Pegs
- > Lifetime Laser-Cut Frame Warranty



## GLS JAMMER ARMS

- > Slide Rail design with UHMWPE bushes lets the user quickly and easily change the height setting without taking the Jammer off the rack.
- > Convergent option lets the handles move towards each other (converge) in a natural arc when you want them to, or stay straight when you don't.
- > Sealed bearings and rugged 75mm box section construction with full commercial 2 year warranty.
- > 110kg Load Capacity (per arm).

## ADJUSTABLE MONOLIFTS

- > Safely lift the bar off without having to walk out
- > Features Sandwich style J-hooks
- > Staple for any strong man lifts
- > Sold in pairs

Monster Series Commercial Performance Rack	5060492994039	PSPR0024
GLS Jammer Arms	5060492995210	PSPR0047
Adjustable Monolift	5060492994671	PSPR0043

CONTACT OUR SALES TEAM ON [SALES@PRIMALSTRENGTH.COM](mailto:SALES@PRIMALSTRENGTH.COM) 0800 689 4021 (OPTION 2) PRIMALSTRENGTH.COM

## MONSTER SERIES

## COMMERCIAL PERFORMANCE RACK WITH 50MM PLATFORM

- > Industry Leading, 1000kg Rated, Commercial Power Rack & 50mm Integrated Platform
- > Overbuilt 270cm, 75mm Box Steel With 2cm Spacing, 37mm Nut & Bolt Heads
- > Premium Rubber Sandwich J-Hooks, Safeties, Front Safeties, Safety Straps
- > Landmine Row, Vertical Bar Holder, 8 Olympic Disc Storage Pins
- > 10 Grip Front Chin Frame, Rear Adjustable/Lockable Angle Chin Handles
- > Plyo Box Rubber Centre Frame, Multiple Leather Rollers, Adjustable Band Pegs
- > Lifetime Laser-Cut Frame Warranty



### JAMMER ARMS FOR HALF & POWER RACKS

- > Adjustable Height Jammer Arms
- > Suitable for our V2 Half Racks in all colour options and also PSPR0005, PSPR0024, PSPR0013, PSPR0031
- > Suitable for 75mm Box Steel Uprights
- > 12 Adjustment Positions



### COMMERCIAL DIP ATTACHMENT

- > Bar Angle Narrows For Multi Width Dips
- > Lifetime Commercial Frame Warranty
- > 250kg Maximum Capacity
- > Fits All Stealth Racks

## COMMERCIAL

## MONSTER RACK SYSTEM

- > Half Power Rack, Functional Trainer, Smith Machine, Lat Pulldown/Row and Vertical Leg Press
- > Two 100kg Weight Stacks with Commercial-Grade Cables & Pulleys
- > 125kg Rear Weight Stacks for Use with the Lat Pull/Low Row Attachments
- > Additional: Chin-Up Frame, Folding Dip Frame, TRX Mount, Landmine/Row Attachment, Multi-Handle Dip Frame, Sandwich J-Hooks, Safety Spotter Bars, Olympic Bar & Disc Storage Pins
- > Integrated Storage
- > Lifetime Commercial Frame Warranty with 400kg Maximum Capacity

 WATCH THE VIDEO ON OUR WEBSITE



### JAMMER ARMS FOR MONSTER RACK SYSTEMS

- > Adjustable Height Jammer Arms
- > Suitable only for PSPR0020
- > 12 Adjustment Positions
- > Light Commercial Warranty



### LEG PRESS ATTACHMENT

- > Extremely quick to set up and remove
- > Perform Single Leg or Dual Leg exercises
- > Perfect for Leg Press and Calf Raise movements
- > Suitable for any user height

Monster Series Commercial Performance Rack with 50mm Platform

5060492991090

PSPR0006

Jammer Arms for Half & Power Racks

5060492993551

PSPR0021

Commercial Dip Attachment

5060492990987

PSPR0008

Commercial Monster Rack System

5060492993599

PSPR0020

Jammer Arms For Monster Rack Systems

5060492994183

PSPR0030

Leg Press Attachment for Elite Power Rack/Smith Machine/Functional Trainer System

5060492992172

PSPR0017



## COMMERCIAL POWER RACK / SMITH MACHINE FUNCTIONAL TRAINER MONSTER SYSTEM

- > Includes: Sandwich J-Hooks, Safety Spotter Bars, Olympic Bar & Disc Storage Pins
- > Includes: Two 100kg Weight Stacks with Commercial-Grade Cables & Pulleys
- > Includes: Chin-Up Frame, Landmine/Row Attachment, Multi-Handle Dip Frame
- > Lifetime Light Commercial Frame Warranty with 400kg Maximum Capacity



## COMMERCIAL V2 FID BENCH WITH CHROME SUPPORTS

- > Shorter Bench Frame for Racks, Functional Trainers & Smith Machines
- > Heavy-Duty Frame with Lifetime Warranty
- > Double Stitched Pads & All Metal Finishes
- > 350kg Max User Weight



## LEG PRESS ATTACHMENT

- > Extremely quick to set up and remove
- > Perform Single Leg or Dual Leg exercises
- > Perfect for Leg Press and Calf Raise movements
- > Suitable for any user height

Commercial Power Rack / Smith Machine / Functional Trainer Monster System	5060492991090	PSPR0006
Commercial V2 FID Bench with Chrome Supports	5060492993605	PSWB0013
Leg Press Attachment for Elite Power Rack/Smith Machine/Functional Trainer System	5060492992172	PSPR0017

## GLS JAMMER ARMS

- > Innovative and unique Registered Design allows countless exercises to be performed in a compact footprint.
- > Slide Rail design with UHMWPE bushes lets the user quickly and easily change the height setting without taking the Jammer off the rack.
- > Indexing mechanism allows user to choose the starting angle of the jammers, solid steel Safety Stop bar lets you lift in safety.
- > Convergent option lets the handles move towards each other (converge) in a natural arc when you want them to, or stay straight when you don't.
- > Sealed bearings and rugged 75mm box section construction with full commercial 2 year warranty.
- > 110kg Load Capacity (per arm).

[▶ WATCH THE VIDEO ON OUR WEBSITE](#)



## JAMMER ARMS FOR MONSTER RACK SYSTEMS

- > Adjustable Height Jammer Arms
- > Suitable only for PSPR0020
- > 12 Adjustment Positions
- > Light Commercial Warranty

GLS Jammer Arms	5060492995210	PSPR0047
Jammer Arms For Monster Rack Systems	5060492994183	PSPR0030
Jammer Arms for Half & Power Racks	5060492993551	PSPR0021

## JAMMER ARMS FOR HALF & POWER RACKS

- > Adjustable Height Jammer Arms
- > Suitable for our V2 Half Racks in all colour options and also PSPR0005, PSPR0024, PSPR0013, PSPR0031
- > Suitable for 75mm Box Steel Uprights
- > 12 Adjustment Positions



### COMMERCIAL PERFORMANCE SAFETY RACK

- > 150mm x 100mm Oversized Tubing
- > Quick Adjustment Oversized J-hooks & Safety Straps
- > Chin-up Handles
- > Landmine Row Attachment



### COMMERCIAL FULL POWER RACK

- > Premium Rubber, Moulded-Sandwich J-Hooks and Spotter Catcher Arms
- > Lifetime Frame Warranty with 500kg Maximum Load Capacity
- > Optional Commercial Safety Straps & Dip Attachment



### YOKE RACK

- > Squat, Press, Push, Carry or Drag. This rack can do it all
- > Featuring 2 x J-hooks to mount a bar for squats, bench press and many more
- > A staple for Strongman training
- > 4 weight loading pins for Olympic Weight Plates
- > Sled feet on every corner
- > Adjustable crossbar height



### FOLDABLE COMMERCIAL POWER RACK

- > Free standing or floor mounted
- > 60mm by 60mm by 3mm thick steel
- > Laser-cut & numbered westside spacing
- > 2 sets of premium J-hooks
- > 1 set of spotters allowing two users to train at once



### V2.0 COMMERCIAL SMITH MACHINE

- > New Design Heavier Duty Frame
- > Commercial Sealed Bearings
- > Ultra-Smooth Bar Glide
- > Rear Plate Storage
- > Chin-up Handles



### V2.0 HD POWER RACK

- > Engineered Using Commercial-Grade, 11 Gauge/3mm Steel- 182kg Weight
- > Lifetime Frame Warranty with 600kg Maximum Load Capacity
- > Multi-Grip Chin-Up Handles
- > Adjustable Spotter Platform (Fold Away)
- > Premium Rubber, Moulded-Sandwich J-Hooks Included
- > 3 Sets of Welded Band Pegs



### LIGHT COMMERCIAL SQUAT RACK

- > Heavy-Duty Squat Stands
- > Premium J-hooks
- > Oversized Safety Spotters
- > Dip Handles



### WALL MOUNTED FOLDABLE RACK

- > Great for Home or Commercial use
- > Folds completely flat
- > Includes Safety Spot Catchers and coated J-Hooks
- > Removable pull up bar/Sled feet on every corner
- > Adjustable crossbar height

Commercial Performance Safety Rack	5060492995142	PSPR0046
Commercial Full Power Rack	5060492991083	PSPR0005
V2.0 HD Power Rack	5060492993124	PSPR0019
Monster Series Smith Machine	5060492997023	PSSS0125

Yoke Rack	5060492994916	PSPR0045
Light Commercial Squat Rack	5060492994459	PSPR0042
Foldable Commercial Power Rack	5060492994268	PSPR0041
Wall Mounted Foldable Rack	5060492994824	PSPR0044



## V3.0 COMMERCIAL HALF RACK

- > Made from Full Commercial Grade, 11 Gauge/3mm Steel with a Lifetime Warranty
- > Unique Multi-Handle, Swivel, Chin-Up and Wall-Climbing Dome Attachments
- > Landmine Row Attachment with T-bar Handle Included
- > Premium Rubber-Moulded Sandwich J Hooks and Spotter Catcher Arms

V3.0 Commercial Half Rack Matte Black	5060492991564	PSPR0014
V3.0 Commercial Half Rack Verde Ithaca	5060492991595	PSPR0015
V3.0 Commercial Half Rack Matte Grey	5060492991601	PSPR0016
V3.0 Commercial Half Rack Hot Pink	5060492993452	PSPR4567
V3.0 Commercial Half Rack Blue	5060492994107	PSPR0027
V3.0 Commercial Half Rack Yellow	5060492994114	PSPR0028
V3.0 Commercial Half Rack Red	5060492994121	PSPR0029



### JAMMER ARMS FOR HALF & POWER RACKS

- > Suitable for our V2 Half Racks in all colour options and also PSPR0005, PSPR0024, PSPR0013, PSPR0031
- > Suitable for 75mm Box Steel Uprights
- > 12 Adjustment Positions



AVAILABLE IN MATTE NERO, VERDE ITHACA, MATTE GREY, HOT PINK, RED YELLOW AND BLUE

## COMMERCIAL PERFORMANCE WALL

- > Lifetime Frame & 1-Year Commercial Warranty
- > Multi-Use Performance Wall
- > Two Power Racks
- > Two Full Platforms
- > Centre Storage



## PT POD

- > Multi-Use PT POD
- > Two Power Racks
- > Centre Storage
- > Suitable for group training
- > Huge Range of Accessories
- > Lifetime Frame & 1-Year Commercial Warranty

Primal Strength Performance Wall

5060492992165 PSPR0013

PT POD

5060492994404 PSPR0031

Central Storage

5060492994381 PSPR0033



## CENTRAL STORAGE

- > Compatible with V3 Half Racks, Performance Walls, PT Pods or Monster Racks
- > Consists of rails, flat shelf and angled shelf
- > 1.8m shelf widths



# MONSTER HYBRID RIG

- > All rigs are fully customisable to suit your demands
- > Providing a multifunctional space suitable for all ages and abilities
- > Flexible attachment options
- > Can be customised and extended
- > Great for small or large spaces alike
- > Perfect for group or one-to-one training situations
- > Made to order with lead times 4-6 weeks



Monster Hybrid Rig

CUSTOM

# GROUP PT RIGS

- > High Quality 60x60x3 steel frame for both uprights and cross members.
- > Laser cut, Robotically Welded & numbered uprights
- > Integrated storage solutions
- > Rubber "sandwich" style J-hooks
- > Angled multi-grip Chinning bars
- > Straight multi-function round bars
- > Landmine attachments, Wall ball targets
- > Power Band pegs, Safety straps, Safety bars
- > Available in three different configurations

GROUP PT RIG 1

GROUP PT RIG 2



Group PT Rig 1	5060492994220	PSPR0037
Group PT Rig 2	5060492994237	PSPR0038
Group PT Rig 3	5060492994244	PSPR0039



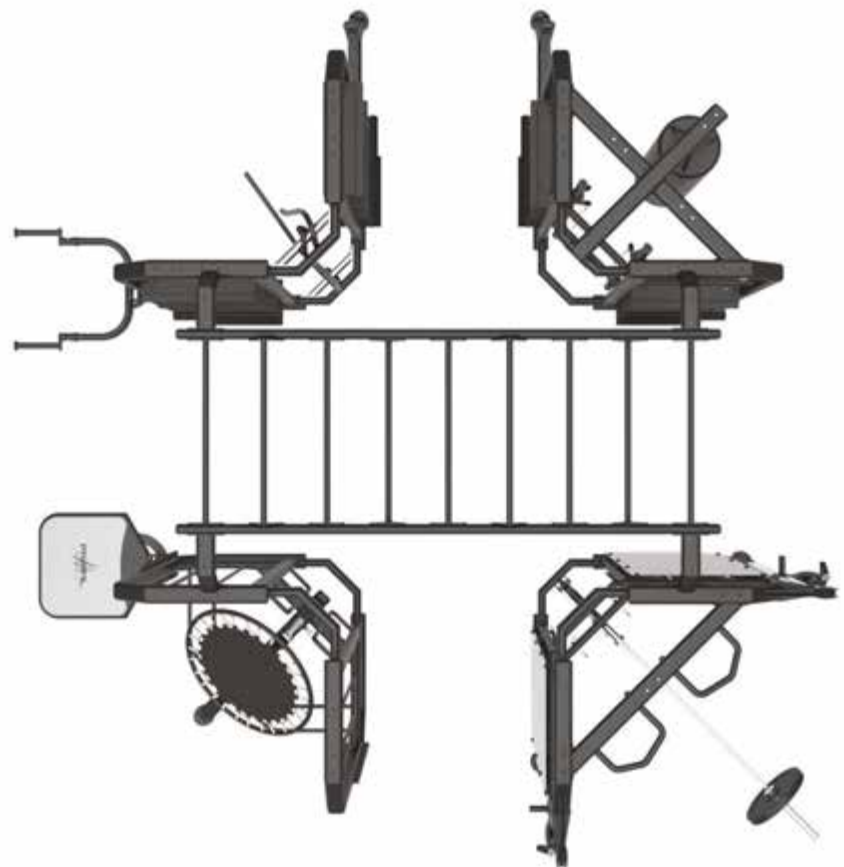

# MONSTER SPYDER RIG

- > 4 Corner Multi-rig
- > Monkey bar Central Frame
- > Dual Pulley, Boxing Frame, Rebounder, Squat Rack & Storage
- > Pull-up Handles, Landmine, Battle Rope, Dip Frame, Plyo Platform
- > Lifetime Frame & 1-Year Commercial Warranty



Spyder Rig

CUSTOM

## RACKS

# PLATE LOADED MACHINES

The Primal Strength Plate Loaded Iso-Series is the ultimate collection of plate loaded equipment.

Specialising in premium, over-built, ergonomically perfect, commercial grade plate loaded machines that cover an extensive array of leg, chest, shoulder and back machines.

The key machines include our V2 Belt Squat, V/ Hack-Squat, T-Bar Row and Iso Chest Press with a fully adjustable air-seat.

The full range is finished in matte black and backed by a lifetime frame warranty, each pad is customisable with your gym logo.



COMMERCIAL ISO  
**INCLINE LEG PRESS**

- > The Primal Strength Commercial Iso Incline Leg Press provides users with a heavy-duty, multi-angle machine, with 3 extended weight-pin holders for maximum pressing weight
- > Full range of depth for heavy-duty leg pressing
- > Converging or diverging range of motion
- > Back-supported leg pressing



COMMERCIAL ISO  
**LINEAR 45 DEGREE LEG PRESS**

- > The Primal Strength Commercial Linear Leg Press provides users with a heavy-duty, multi-angle leg press machine, with 4, extended weight-pin holders for maximum pressing weight
- > Heavy-duty, multi-angle leg press machine
- > 45 Degree Angle with Linear Bearings
- > Oversized, angled foot plate



COMMERCIAL ISO  
**HACK/V SQUAT**

- > The Primal Strength Commercial ISO V and Hack Squat provides users with a heavy-duty, dual use machine, with the option of both a back-supported Hack Squat and a full front facing V Power Squa Maximise weight used whilst applying a natural lifting motion
- > Converging or diverging range of motion
- > Safely isolating muscle groups



COMMERCIAL ISO  
**V2 BELT SQUAT MACHINE**

- > High Quality heavy gauge steel frame with a 600kg load capacity
- > Lever arm length and handle heights adjust to suit your height and squatting style
- > Compact 202cm x 120cm footprint
- > Ultra smooth Industrial grade pillow block bearings
- > 300kg load capacity for Dips handles (included)



COMMERCIAL ISO  
**SEATED CALF MACHINE**

- > The Primal Strength Commercial ISO Seated Calf Machine provides users with a full range of motion to stretch and press their calf musclesConverging and diverging range of motion
- > Safely isolates muscle groups whilst allowing maximum weights to be lifted
- > Ensures a natural lifting motion



COMMERCIAL ISO  
**LEVERAGE SQUAT**

- > The Primal Strength Commercial ISO Leverage Squat provides users with a heavy-duty, dual use machine, with the option of both leverage squats and calf raises
- > Full range of depth for both Hack and Power Squat
- > Safely isolating muscle groups

Commercial ISO Incline Leg Press	5060492991038	PSSS0014
Commercial ISO Linear 45 Degree Leg Press	5060492993513	PSSS0061
Commercial ISO Hack/V Squat	5060492991021	PSSS0013

Commercial ISO Leverage Squat	5060492996071	PSSS0083
Commercial ISO V2 Belt Squat machine	5060492993858	PSSS0072
Commercial ISO Seated Calf Machine	5060492991014	PSSS0012



### COMMERCIAL ISO STANDING HAMSTRING CURL

- > The Primal Strength Commercial Standing Hamstring Curl is the ultimate machine to isolate hamstrings
- > 3mm Commercial Steel Plate-Loading Machine
- > Standing Hamstring Curl
- > Adjustable Height to Perfectly Isolate Hamstrings
- > Extended, Olympic Weight-Pin Holder for Maximum Load
- > Premium Pads & Rubber and Aluminium-Capped Handles



### COMMERCIAL ISO GLUTE DRIVE

- > Adjustable Length to Accommodate Any User Size
- > Adjustable Angle for Perfect Isolation
- > Auto-Lock Padded Belt
- > Oversized Bullhorns for Maximum Load Capacity



### COMMERCIAL ISO PENDULUM SQUAT

- > Allows for Back Supported Heavy Squat Movements
- > Adjustable Foot Platform For Leg Isolation
- > Adjustable Depth Safety
- > Oversized Footplate



### COMMERCIAL ISO LEG EXTENSION

- > Olympic Size 50mm Bullhorn
- > Adjustable Back Rest
- > Oversized Pads
- > Lifetime Frame Warranty



### COMMERCIAL ISO GLUTE KICK BACK

- > The Primal Strength Commercial Glute Kick-Back offers a natural and very 'true' kick back/rear pressing motion and is a 'must have' item for any gyms leg training equipment.
- > Brushed Steel Foot Plate
- > Extended Olympic Weight-Pin Holders for Maximum Load
- > Ergonomically Designed to Move in The Body's Natural Motion



### COMMERCIAL ISO NORDIC CURL

- > Recognised as 1 of the best hamstring exercises for both muscle activation and injury prevention
- > Progressive, adjustable movement stopper let's you build range of motion over time.
- > Adjustable assistance from Weights, Bands, or both, so you can progress to full body weight.
- > High density comfort top pads eliminate pain in the kneeling posture.

Commercial ISO Standing Hamstring Curl

5060492993315

PSSS0059

Commercial ISO Pendulum Squat

5060492996897

PSSS0123

Commercial ISO Glute Drive

5060492996903

PSSS0124

Commercial ISO Nordic Curl

5060492997078

PSSS0130

Commercial ISO Leg Extension

5060492993506

PSSS0060

Commercial ISO Glute Kick Back

5060492993292

PSSS0055



COMMERCIAL ISO  
**LAT PULL DOWN**

- > The Commercial ISO Lat Pull-Down offers a natural and very 'true' lat pull-down motion
- > Independent movement of each machine arm
- > Converging or diverging range of motion
- > Safely isolates muscle groups



COMMERCIAL ISO  
**FULL BACK ROW**

- > The Primal Strength Commercial ISO Full Back Row offers a natural and very 'true' row motion. Independent movement of each machine arm
- > Converging or diverging range of motion
- > Safely isolating muscle groups



COMMERCIAL ISO  
**CHEST SUPPORTED T-BAR ROW**

- > The Primal Strength Commercial ISO Incline Row offers a chest-supported and very natural incline row motion. Support Pad for safe, heavy-duty rows
- > Converging or diverging range of motion
- > Safely isolating muscle groups



COMMERCIAL ISO  
**STANDING T-BAR ROW**

- > Heavy-duty 4mm Steel T-Bar Row
- > Adjustable Width Handles With Multiple Grips
- > Extended Bullhorns
- > Band Pegs for Additional Resistance



COMMERCIAL ISO  
**CAMBERED BICEP CURL**

- > Olympic Size 50mm Bullhorn
- > Adjustable Seat
- > Oversized Pads
- > Lifetime Frame Warranty



COMMERCIAL ISO  
**LOW BACK ROW**

- > The Primal Strength Commercial ISO Low Back Row offers a natural and very 'true' low row motion
- > Independent movement of each machine arm
- > Converging or diverging range of motion
- > Safely isolating muscle groups

Commercial ISO Lat Pull Down	5060492990987	PSSS0009
Commercial ISO Full Back Row	5060492990994	PSSS0010
Commercial ISO Incline T-Bar Back Row	5060492991007	PSSS0011

Commercial ISO Low Back Row	5060492993315	PSSS0057
Commercial ISO Cambered Bicep Curl	5060492993520	PSSS0062
Commercial ISO Standing T-Bar Row	5060492996156	PSSS0118





COMMERCIAL ISO  
**CHEST PRESS**

- > The Primal Strength Commercial ISO Chest Press offers a natural and very 'true' pressing motion and is a 'must have' item for any commercial gym or sports facility.
- > Independent movement of each machine arm
- > Converging or diverging range of motion
- > Safely isolating muscle groups

Commercial ISO Chest Press      5060492990963      PSSS0007



COMMERCIAL ISO  
**HORIZONTAL CHEST PRESS**

- > Ergonomically Designed for a Full Range of Motion When Pressing
- > Independent Arms
- > Oversized Bullhorns
- > Commercial Pillow Block Bearings
- > Lifetime Frame Warranty



COMMERCIAL ISO  
**TRICEP DIP**

- > Designed to fully isolate the tricep and chest muscles
- > Can be used with both arms simultaneously or single arm alternatively
- > Adjustable seat for comfort and stability
- > Extra long bull horns
- > 2 storage bull pins



COMMERCIAL ISO  
**INCLINE CHEST PRESS**

- > The Primal Strength Commercial Iso Incline Chest Press offers a natural and very 'true' pressing motion and is a 'must have' item for any commercial gym or sports facility. Independent movement of each machine arm
- > Converging or diverging range of motion
- > Safely isolating muscle groups

Commercial ISO Tricep Dip	5060492997054	PSSS0128
Commercial ISO Incline Chest Press	5060492993308	PSSS0056
Commercial ISO Horizontal Chest Press	5060492997061	PSSS0129



COMMERCIAL ISO

# SHOULDER PRESS

- > The Primal Strength Commercial ISO Shoulder Press offers a natural and very "true" pressing motion.
- > 9 Gauge/4mm Commercial Steel, ISO Lever, Plate-Loading Machine
- > Unique, Quick-Release Seat Adjustment
- > Extended, Olympic Weight-Pin Holders for Maximum Load

Commercial ISO  
Shoulder Press

5060492990970

PSSS0008

 WATCH THE VIDEO ON  
OUR WEBSITE

PLATE LOADED MACHINES

# SINGLE/MULTI STATION MACHINES

Primal Strength has two core ranges; the Commercial series and the Monster series. Our Commercial series has been designed to offer the best value for money whilst ensuring that the product has optimum functionality.

CONTACT OUR SALES TEAM ON [SALES@PRIMALSTRENGTH.COM](mailto:SALES@PRIMALSTRENGTH.COM) 📞 0800 689 4021 (OPTION 2) [PRIMALSTRENGTH.COM](http://PRIMALSTRENGTH.COM)

## THE MONSTER SERIES

The Primal Strength Monster Cable Series is our Commercial Cable Series using the heaviest-duty cable machines available. The complete range includes some of the most popular strength machines, including; Height Adjustable Side-Lat Raise, Adjustable Pec-Dec/Rear Fly, Prone Leg Curl and our 125kg Monster Series Lat Pull Down.



### MONSTER SERIES 125KG LAT PULLDOWN

- > Adjustable-Height knee Support
- > 125kg Stack (5kg Increments)
- > 1000kg Rated Cables
- > Heavy-Duty Frame & Laser Cut Stack Shroud



### MONSTER SERIES 75KG STANDING LAT RAISE

- > Ultra-Smooth Pivot Bearing Handles
- > Gas Powered Adjustable Foot Plate
- > 75kg Stack (5kg Increments)
- > Heavy-duty Frame & Laser-Cut Stack Shroud



### MONSTER SERIES 100KG SUPPORTED CHIN-DIP

- > Sealed Bearings with a locking base
- > Dual Handle Chin-Ups & Extended Dip bars
- > 100kg Stack (5kg Increments)
- > Heavy-duty Frame & Laser-Cut Stack Shroud



### MONSTER SERIES 125KG LEG EXTENSION

- > Small CAM design for direct 1:1 Ratio
- > 125kg Stack (5kg Increments)
- > 7-Point Foot Adjustment & Adjustable back Rest
- > Heavy-duty Frame & Laser-Cut Stack Shroud



### MONSTER SERIES 100KG PRONE HAMSTRING CURL

- > Multiple Adjustment Foot Positions for Isolation
- > 100kg Stack (5kg Increments)
- > Split pad for Perfect positioning
- > Heavy-duty Frame & Laser-Cut Stack Shroud



### MONSTER SERIES 100KG ABDUCTOR/ ADDUCTOR

- > Instantly Change Pads Between Ab/Adductor
- > Smooth Sealed Bearings and 1000kg Rated Cables
- > 100kg Stack (5kg Increments)
- > Heavy-duty Frame & Laser-Cut Stack Shroud

Monster Series 125kg Lat Pull Down	5060492996958	PSSS0081
Monster Series 75kg Standing Lat Raise	5060492997122	PSSS0133
Monster Series 100kg Supported Chin-Dip	5060492996965	PSSS0109

Monster Series 125kg Leg Extension	5060492996873	PSSS0077
Monster Series 100kg Prone Hamstring Curl	5060492997009	PSSS0115
Monster Series 100kg Abductor/Adductor	5060492996989	PSSS0076





### MONSTER SERIES 100KG PEC DEC & REAR FLY

- > Ultra-Smooth Pillow Block Bearings
- > Adjustable Pad Angle & Seat Height
- > 100kg Stack (95kg Increments)
- > Heavy-duty Frame & Laser-Cut Stack Shroud



### MONSTER SERIES 125KG CHEST PRESS

- > Adjustable Back Rest for Multi-Angle Press
- > 125kg Stack (5kg Increments) & 1000kg Rated Cables
- > Multi Seat Height & Hand Positions
- > Heavy-duty Frame & Laser-Cut Stack Shroud



### MONSTER SERIES 100KG SHOULDER PRESS

- > Adjustable Back Rest for Multi-Angle Shoulder Press
- > 100kg Stack (5kg Increments) & 1000kg Rated Cables
- > Multi Seat Height & Hand Positions
- > Heavy-duty Frame & Laser-Cut Stack Shroud



### MONSTER SERIES 100KG ARM CURL

- > Adjustable Seat Height & Heavy-duty Curl pad
- > Small Cam for Direct Ratio
- > 100kg Stack (5kg Increments)
- > Heavy-duty Frame & Laser-Cut Stack Shroud

Monster Series 125kg Chest Press	5060492996835	PSSS0080
Monster Series 100kg Pec Dec & Rear Fly	5060492996941	PSSS0108
Monster Series 100kg Shoulder Press	5060492996859	PSSS0082
Monster Series 100kg Arm Curl	5060492996897	PSSS0112

SINGLE/MULTI STATION MACHINES



### THE COMMERCIAL SERIES

Our Commercial series has been designed to offer the best value for money whilst ensuring that the product has optimum functionality. This range includes our dual function machines which offer a space saving option for many facilities, our light-commercial benches and rubber dumbbells.

### COMMERCIAL 5 STACK MULTI STATION

- > Commercial 5-Station Includes: 100kg Low Row, 100kg Lat Pull Down, 2x100kg Dual-Cable Crossover Pulley, 100kg High Pulley/ Push Down
- > Includes Five 100kg Stacks and Accessories or Each Station
- > Commercial Grade Cables, Bush Bearing Pulleys and Metal Pop Pins with Metal Shroud Guards
- > Double-Stitched, Rip-Resistant, Commercial Grade Seats and Pads



### COMMERCIAL ELITE 4 STACK MULTI STATION

- > Commercial, Four-Stack Multi-Station Includes: Supported Low Row, Lat Pull Down, Cable Pulley, High Pulley Push Down
- > Includes Four 100kg Stacks and Accessories for Each Station
- > Commercial Grade Cables, Bush Bearing Pulleys and Metal Pop Pins with Metal Shroud Guards
- > Can be Configured with Another Four Stack to Include a Full Cable Crossover

Commercial Fitness Elite 4 Stack Multi Station	5060492990918	PSSS0004
Commercial 5 Stack Multi Station	5060492996644	PSSS0120

CONTACT OUR SALES TEAM ON [SALES@PRIMALSTRENGTH.COM](mailto:SALES@PRIMALSTRENGTH.COM) 0800 689 4021 (OPTION 2) [PRIMALSTRENGTH.COM](http://PRIMALSTRENGTH.COM)





## FUNCTIONAL TRAINER DUAL ADJUSTABLE PULLEY

- > Commercial, Heavy-duty, Dual-Adjustable Pulley Trainer
- > Two 100kg Weight Stacks in 5kg Increments
- > Full Range of Commercial, Hardened-Chrome Accessories with Training Chart
- > Premium, Full Length, Rubber Grip Chin-Up Bar with Support Step



## COMMERCIAL DUAL ARM CABLE PULLEY

- > 2x100kg Individual stacks
- > Multi-Height Adjustable Arms
- > Full Range Arm Motion
- > Matte Black Powder Coated
- > Brass Bushings
- > 1000kg Rated Cables



## COMPACT LIGHT COMMERCIAL DUAL ADJUSTABLE PULLEY 90KG STACKS

- > 90kg Weight Stacks
- > Range of Accessory Handles Included
- > 15 Pulley Positions
- > Light-Commercial Warranty

Functional Trainer Dual Adjustable Pulley 5060492990925 PSSS0005

Dual Abductor/Adductor 90kg stack 5060492996620 PSSS0116

Commercial Dual Arm Cable Pulley 5060492993216 PSSS0117

### SINGLE/MULTI STATION MACHINES

# COMMERCIAL LEG EXTENSION 125KG STACK

- > 125kg weight stack in 5kg increments
- > Adjustable Back Rest
- > Adjustable Foot Pad Angle
- > Double Stitched and Sealed Pads
- > Lifetime Frame Warranty

Commercial Leg Extension 125kg Stack 5060492994008 PSSS0031





## DUAL LEG EXTENSION/LEG CURL SELECTORISED MACHINE

- > 100kg Weight Stack
- > Premium Design Seats, Pads & Finishes
- > Ergonomically Designed, Multi User Position
- > 1000kg Tested Cables



## DUAL ABDUCTOR/ADDUCTOR 90KG STACK

- > Premium double-stitched leather
- > Revolving knee pads for comfort
- > 90kg weight stack
- > Adjustable to 8 positions



## LEG PRESS SELECTORISED MACHINE

- > Commercial Dual-Series Strength Machines
- > Heavy Weight Stack [125kg]
- > Premium Design Seats, Pads & Finishes
- > Ergonomically Designed, Multi User Positions
- > 1000kg Tested Cables

Dual Leg Extension / Leg Curl Selectorised Machine	5060492993162	PSSS0025
Dual Abductor/Adductor 90kg stack	5060492996620	PSSS0116
Leg Press Selectorised Machine	5060492993216	PSSS0030

SINGLE/MULTI STATION MACHINES

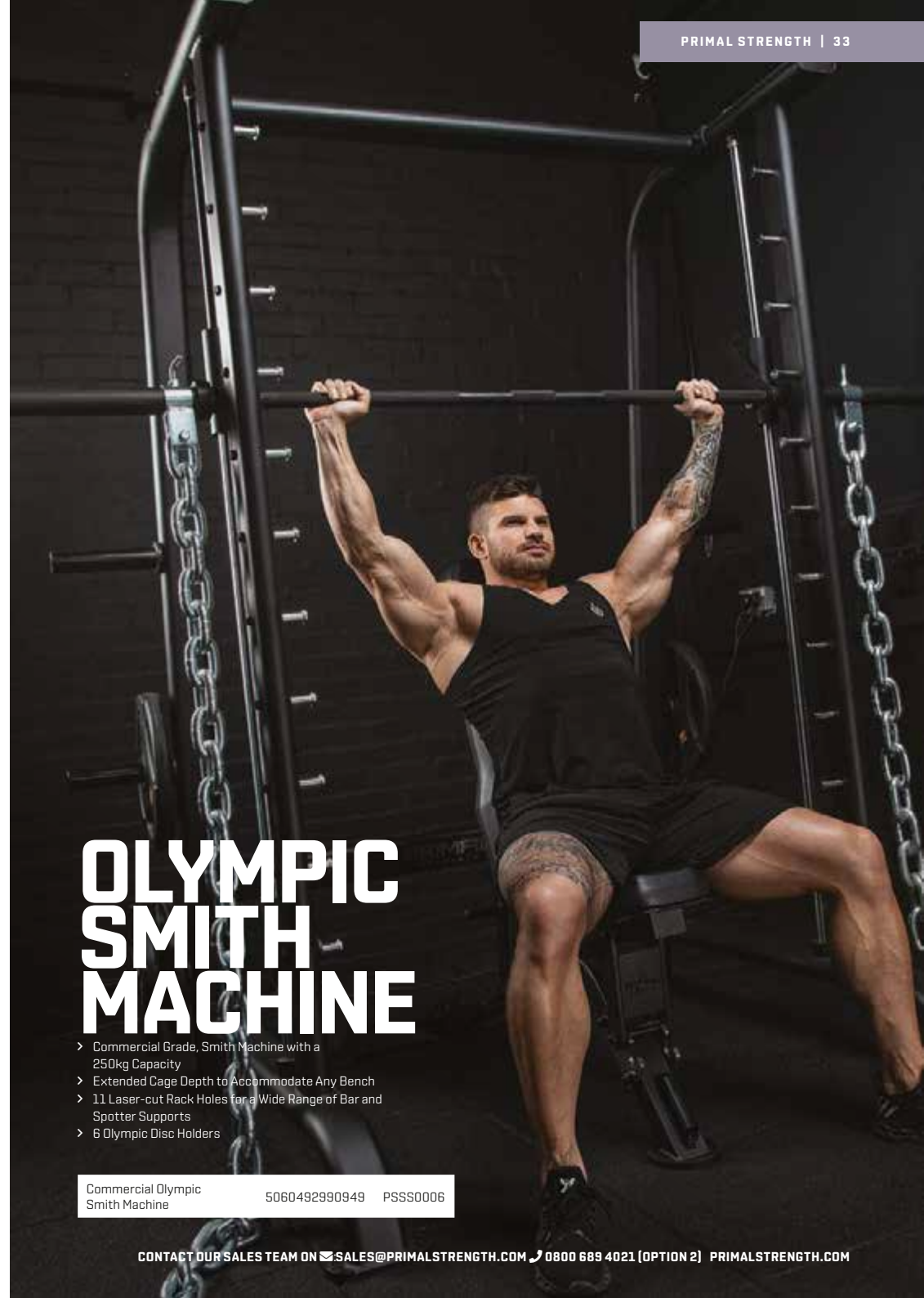

# OLYMPIC SMITH MACHINE

- > Commercial Grade, Smith Machine with a 250kg Capacity
- > Extended Cage Depth to Accommodate Any Bench
- > 11 Laser-cut Rack Holes for a Wide Range of Bar and Spotter Supports
- > 6 Olympic Disc Holders

Commercial Olympic Smith Machine	5060492990949	PSSS0006
----------------------------------	---------------	----------

CONTACT OUR SALES TEAM ON [SALES@PRIMALSTRENGTH.COM](mailto:SALES@PRIMALSTRENGTH.COM) 0800 689 4021 (OPTION 2) [PRIMALSTRENGTH.COM](http://PRIMALSTRENGTH.COM)



## DUAL PEC FLY / REAR DELT SELECTORISED MACHINE

- > The Dual Pec Fly/ Rear Delt has independent arms for optimised variety and feel
- > Heavy Weight Stack ( 90kg)
- > Premium Design Seats, Pads & Finishes
- > Ergonomically Designed, Multi User Position
- > 1000kg Tested Cables



## DUAL CHEST / SHOULDER PRESS SELECTORISED MACHINE

- > The Dual Chest / Shoulder press offers the best in combination machines, and saves space too with its multi-function design
- > Heavy Weight Stack (100kg)
- > Premium Design Seats, Pads & Finishes
- > 1000kg Tested Cables



## DUAL LAT PULLDOWN/SEATED ROW SELECTORISED MACHINE

- > The Lat Pulldown / Seated Row accommodates two exercises that target the entire back and rear shoulder muscle groups
- > Heavy Weight Stack (100kg)
- > Premium Design Seats, Pads & Finishes
- > Ergonomically Designed, Multi User Position
- > 1000kg Tested Cables



## LOW ROW SELECTORISED MACHINE

- > The Low Row Selectorised Machine enables users to workout their back and lats
- > Heavy Weight Stack (125kg)
- > Premium Design Seats, Pads & Finishes
- > Ergonomically Designed, Multi User Position
- > 1000kg Tested Cables



## DUAL ASSISTED CHIN/DIP SELECTORISED MACHINE

- > The Dual Assisted Chin / Dip allows the user to either work their back muscles using the pull up function or focus on their arms (triceps ) and chest with the dip option
- > Heavy Weight Stack (100kg)
- > Premium Design Seats, Pads & Finishes
- > 1000kg Tested Cables



## CABLE SIDE LATERAL RAISE MACHINE 100KG STACK

- > The Cable Lat Raise can be used both forward and rear facing to hit delts from multiple angles
- > Commercial Cable Lat Raise
- > Front & Rear Facing
- > Quick Release, Multi-Height Seat
- > Heavy-Duty 100KG Stack
- > Premium Pads & Components
- > Lifetime Frame Warranty

Dual Chest / Shoulder Press Selectorised Machine	5060492993179	PSSS0026
Dual Lat Pulldown / Seated Row Selectorised Machine	5060492993186	PSSS0027
Dual Pec Fly / Rear Delt Selectorised Machine	5060492993193	PSSS0028

Dual Assisted Chin / Dip Selectorised Machine	5060492993230	PSSS0032
Low Row Selectorised Machine	5060492993247	PSSS0033
Cable Side Lateral Raise Machine 100kg Stack	5060492993544	PSSS0064





## CABLE CROSSOVER 2 X 100KG STACK

- > The Primal Strength Commercial Cable Crossover has been engineered to be an ultra-smooth, cable crossover that will be a core piece of equipment in any commercial training facility
- > Two 100kg Weight Stacks
- > 5kg Increments

## LAT PULL DOWN 125KG STACK

- > The Commercial Series lat Pulldown targets the upper back and rear shoulder muscle groups
- > Heavy Weight Stack (125kg)
- > Premium Seat Pads & Finishes
- > Ergonomically Designed Cable Angle
- > Lifetime Frame Warranty



Commercial Lat Pull Down 125kg Stack

5060492993322

PSSS0058

Commercial Cable Crossover 2 x 100kg stack

5060492993537

PSSS0063

SINGLE/MULTI STATION MACHINES



# PLATFORMS

Primal Strength offer several bespoke platform options.

20mm and 40mm custom branded insert seamlessly fit into our EPDM matting. Our Best-selling standalone 2.5m x 2m 30mm platform with steel frame and band pegs. The range is completed with the Primal Strength 30mm and 50mm fully integrated rack platforms for both our commercial half and full racks and our Monster Performance Rack.

CONTACT OUR SALES TEAM ON [SALES@PRIMALSTRENGTH.COM](mailto:SALES@PRIMALSTRENGTH.COM) 0800 689 4021 (OPTION 2) [PRIMALSTRENGTH.COM](http://PRIMALSTRENGTH.COM)



COMMERCIAL  
**OLYMPIC LIFTING PLATFORM  
 WITH STEEL FRAME  
 AND BAND HOOKS**

- > 2.5m Wide by 2m Deep Platform with Steel Frame
- > Heavy-Duty Wood Centre
- > Recycled Premium Rubber Sides
- > Power Band Pegs
- > 30mm Platform Depth



COMMERCIAL  
**INTEGRATED OLYMPIC  
 LIFTING PLATFORM  
 FOR STEALTH HALF  
 RACK / FULL RACK**

- > 2.57m Wide by 3.67m Deep Platform
- > Heavy-Duty Wood Centre
- > Premium Rubber Side Tiles
- > Steel Laser Cut Frame with Removable Power Band Pegs
- > 30mm Platform Depth



Integrated Olympic Lifting Platform for Stealth Half Rack / Full Rack

5060492992806

PSLP0002

Olympic Lifting Platform with Steel Frame and Band Hooks

5060492991472

PSLP0001

**PLATFORMS**

# CUSTOM PLATFORM INSERTS

As part of our custom service we can provide Custom Platform inserts in 20mm,30mm and 40mm. These can be dual-branded or with a single brand.

Custom Platform Inserts

CUSTOM



# BENCHES

Primal Strength offer a range of premium light commercial and commercial benches. The range is led by our Commercial V2 FID Bench, fully adjustable with 10mm chromed back support.

The range is completed with our IPF Combo Bench and Olympic Benches.

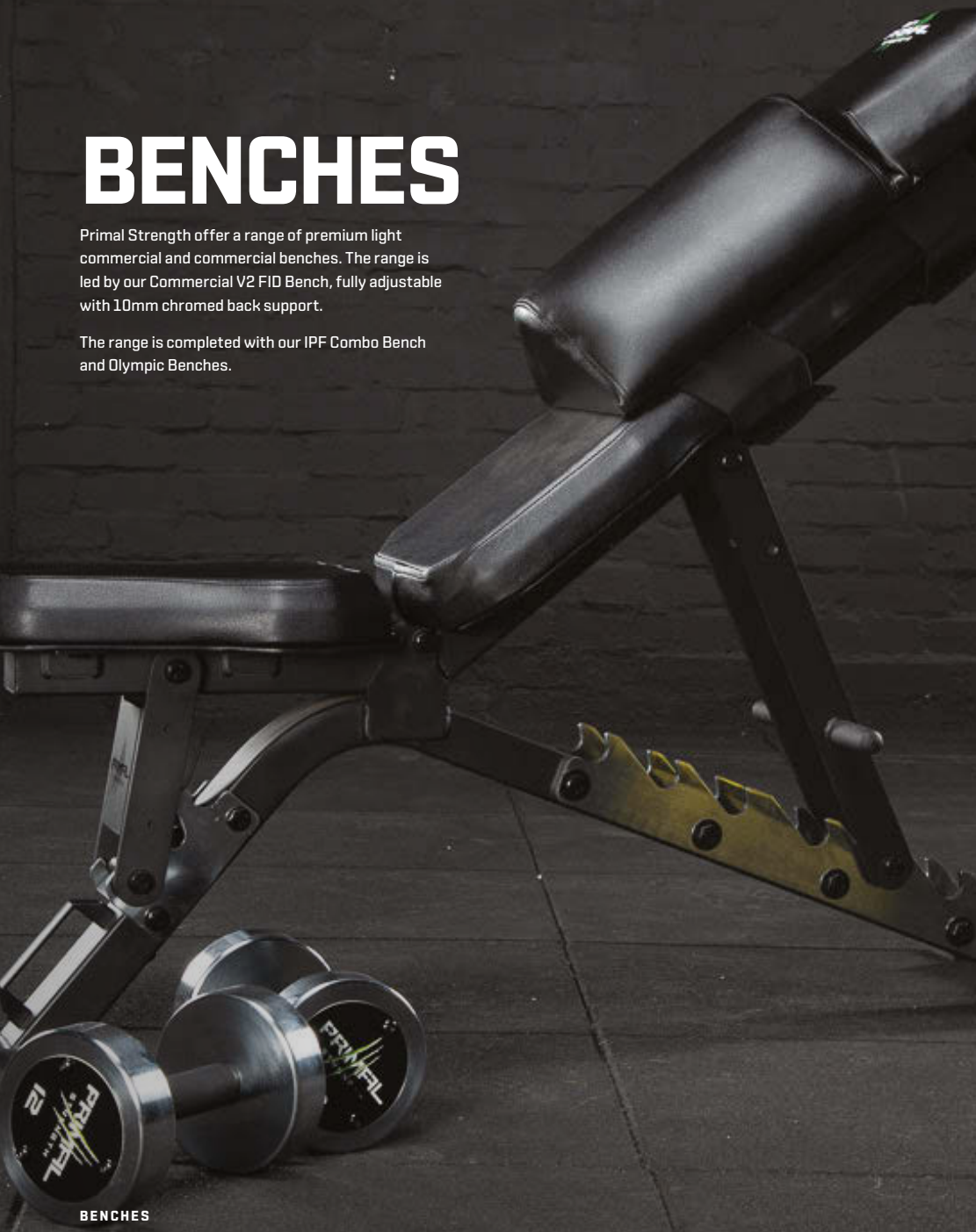

BENCHES



## MULTI ADJUSTABLE BENCH WITH FOOT SUPPORT

- > Multi-Adjustable Light Commercial FID Bench
- > Adjustable Foot Support
- > 6 Angle Back Pad, 3 Angle Seat
- > Lifetime Frame & One Year LC Parts

## V2 FID BENCH WITH CHROME SUPPORTS

- > Full Commercial, Premium, Flat/Incline/Decline Bench
- > Custom Gym Logo Available
- > Made from 3mm Steel with 10mm Chrome Wave
- > Heavy-duty Frame with Lifetime Warranty
- > Premium, Angled Pads
- > 500kg Max User Weight & All Metal Finishes
- > AVAILABLE IN VARIOUS COLOURS AND CUSTOM WRAPS



AVAILABLE IN MATTE NERO, MATTE GRIGIO, VERDE ITHACA, HOT PINK, RED AND BLUE

Matte Nero	5060492993605	PSWB0013
Matte Grigio	5060492994138	PSWB0017
Verde Ithaca	5060492990031	PSWB0004
Hot Pink	5060492994145	PSWB0018
Yellow	5060492994169	PSWB0020
Red	5060492994176	PSWB0021
Blue	5060492994152	PSWB0019



## COMMERCIAL ADJUSTABLE FLAT INCLINE/DECLINE BENCH

- > Full Commercial, Premium, FID Bench
- > Shorter Bench Frame for Racks, Functional Trainers & Smith Machines
- > Heavy-Duty Frame with Lifetime Warranty
- > Double Stitched Pads & All Metal Finishes
- > 350kg Max User Weight

Commercial FID Bench, Adjustable Flat/Incline/Decline	5060492990901	PSWB0007
Multi Adjustable Bench with Foot Support	5060492994831	PSWB0023





### COMMERCIAL FLAT DUMBBELL BENCH

- > Full Commercial, Premium, Flat Dumbbell Bench
- > Heavy-duty Frame with Lifetime Warranty
- > Double Stitched Pad & All Metal Finishes
- > Transport Wheels
- > 350kg Max User Weight



### COMMERCIAL FLAT BOX BENCH

- > Fully Commercial, Premium, Dumbbell Bench
- > Box Shape, Heavy-Duty, 3mm Commercial Steel Frame
- > Lifetime Frame Warranty
- > 400kg Max User Weight



### COMMERCIAL FLAT AND INCLINE BOX BENCH

- > Fully Commercial, Premium, Adjustable, Flat Incline Bench
- > Multi-Angle Pads with Quick Release Pop Pins
- > Lifetime Frame Warranty
- > 400kg Max User Weight



### MONSTER SERIES COMMERCIAL FLAT DUMBBELL BENCH

- > 450kg Capacity
- > Fully Welded Frame
- > Handle & Roller Wheels
- > Lifetime Frame Warranty

Commercial Flat Box Bench	5060492992158	PSWB0012
Commercial Fitness Elite Flat Dumbbell Bench	5060492990932	PSWB0008
Commercial Flat and Incline Box Bench	5060492992141	PSWB0011
Monster Series Commercial Flat Dumbbell Bench	5060492992318	PSWB0053

#### BENCHES

# CUSTOM BENCH WRAPS

As part of our custom service we can provide Custom Bench Wraps with your logo embroidered in full colour. These wraps can be used on any of the Iso Commercial range as well.

Custom Bench Wraps

CUSTOM

COMMERCIAL

# ADJUSTABLE OLYMPIC BENCH WITH SPOTTER & PLATFORM

- > Built to IPF Specification with a 600kg Weight Capacity
- > Adjustable Height of Safety Spotters & Bar Holders
- > Metal Commercial-Grade Pop-Pins for Quick and Easy Adjustment
- > Lifetime Frame Warranty, Using High Quality 4mm Heavy-Gauge Steel

Commercial Adjustable Olympic Bench With Spotter & Platform 5060492990949 PSSS0006



## LIGHT COMMERCIAL SISSY SQUAT

- > Adjustable Leg Support with Quick Release Pop Pin
- > Oversized Commercial Foam Pads with Rip-Resistant Covers
- > Metal Non-Slip Footplate and Metal End Caps



## COMMERCIAL SISSY SQUAT

- > Heavy-duty Sissy Squat
- > Adjustable Height
- > Adjustable Angled Foot Support
- > Premium Commercial Pads



## COMMERCIAL GHD MULTI ADJUSTABLE WITH BAND HOOKS

- > Quick-Release, Multi-Adjustable Length & Height Set-Up
- > Power Band Pegs for Additional Power Training
- > Support Handles and Over-Sized, Non-Slip Foot Plate
- > Commercial-Grade Steel, Powder Coated with a Lifetime Frame Warranty



## MONSTER SERIES HIP THRUST FLOOR GHD

- > Adjustable Height Hip Thrust Pad
- > Adjustable Foot Supports
- > Movable Pads for Knee Support
- > Oversized Frame on Wheels/Stands Upright
- > 8 Band Pegs Per Side

Commercial GHD Multi Adjustable with Band Hooks	5060492992127	PSSS0054
Light Commercial Sissy Squat	5060492990888	PSAC0034
Monster Series Hip Thrust Floor GHD	5060492992899	PSSS0054
Commercial Sissy Squat	5060492994848	PSAC0128





### COMMERCIAL HYPER EXTENSION/ ROMAN CHAIR

- > Oversized Dual Pads for Comfort
- > Quick-Release, Multi-Adjustable Set-Up
- > Brushed Steel, Non-Slip Large Foot Plate
- > 3mm Commercial-Grade Steel, Powder Coated Matte
- > Lifetime Frame Warranty



### LIGHT COMMERCIAL HIP THRUST BENCH & FLOOR GHD

- > Oversized Hip Thruster Pad
- > Adjustable GHD Leg Support Heights & Non-Slip Foot Plate
- > Compact Design on Wheels
- > Commercial-Grade Steel, Powder Coated with a Lifetime Frame Warranty



### COMMERCIAL INCLINE OLYMPIC BENCH

- > Heavy-Duty Incline Olympic Bench
- > Adjustable Seat Height
- > Two Safety Spotters with Rubber Finishing
- > Premium Rip-Resistant pads
- > 350kg Capacity



### COMMERCIAL OLYMPIC SAFETY BENCH

- > Industry Leading, 1000kg Rated, Commercial Safety Bench
- > Premium Fat Pad back support - 75mm deep, 355mm wide and 1320mm in length
- > Premium Rubber Sandwich J-Hooks and Safety Straps
- > 6 Band hooks
- > Non-slip spotter platform
- > Adjustable to 14 heights



### LIGHT COMMERCIAL PREACHER CURL BENCH

- > Ergonomically Design Pad for the Perfect Curl Angle
- > Adjustable Seat Height
- > Low-Height Bar Catcher Allows Full Range of Motion



### DUAL COMMERCIAL PREACHER CURL

- > Dual Scott Curl & Angled pad
- > Urethane Protected Safety Arms
- > Oversized Tubing
- > Injection Moulded Pads



### MONSTER PREACHER CURL

- > Oversized Tube Frame
- > Adjustable Seat Height
- > Dual Bar Placement
- > Injection Moulded Pads



### COMMERCIAL OLYMPIC DECLINE BENCH

- > 350kg Capacity
- > Fully Welded Frame
- > Handle & Roller Wheels
- > Lifetime Frame Warranty



### COMMERCIAL COMBO IPF BENCH

- > IPF Competition Spec Combo Rack Bench allows both Squat and Bench press
- > High Quality heavy gauge steel frame with Lifetime warranty
- > Fully adjustable to suit all user heights
- > Locking height adjustable bench press safety catchers

Commercial Hip Thruster Bench & Floor GHD	5060492992134	PSSS0038
Commercial Hyper Extension/Roman Chair	5060492993438	PSWB0055
Dual Commercial Preacher Curl	5060492996910	PSSS0121
Light Commercial Preacher Curl Bench	5060492993254	PSSS0034
Monster Preacher Curl	5060492997153	PSWB0208

Commercial Olympic Safety Bench	5060492995203	PSWB0024
Commercial Incline Olympic Gym Bench	5060492993339	PSWB0054
Commercial Olympic Decline Gym Bench	5060492993476	PSWB0057
Commercial Combo IPF Bench	5060492993834	PSWB0016

# OLYMPIC BARS & COLLARS

Primal Strength offer a variety of Olympic Bars. Unique designs include our Multi-grip Shrug Bar and our trusted "it's Heavy" 8-Needle Dual Olympic Bar. The Primal Strength Collars are built to last, whilst being quick and easy to use.

OLYMPIC BARS & COLLARS



## MULTI GRIP OLYMPIC SHRUG BAR

- > Unique, Rotating, Knurled, Multi-Grip Handles to Build Grip Strength
- > Matte Black Frame with a Lifetime Warranty
- > 450kg Max Capacity



## OPEN HEX TRAP BAR

- > Perfectly Balanced
- > Open Access
- > Three Grips from 25-45mm
- > Oversized Bullhorns



## RUSSIAN 28MM OLYMPIC BAR & COLLARS

- > Premium Russian Sleeve Design Olympic bar
- > Unique Quick-Lock/Release Collars Included
- > Perfect for Multi-Rep Olympic Lifting
- > 28mm Knurl/50mm Sleeve, 8-needle bearing
- > Medium to Good Whip 200,000PSI



## 230CM OLYMPIC DEADLIFT BAR

- > Longer Bar for More Bar-Bend From The Floor
- > 27mm Diameter Bar Grip, 50mm Plate Sleeves
- > Aggressive Knurl, Powerlifting Lines
- > Good Whip, 190,000 PSI
- > Finished in Ionised Black
- > 3 Year No Bend Warranty\*



## SAFETY SQUAT BAR

- > 300kg Weight Capacity (fully welded)
- > 50mm Olympic End Caps
- > Lifetime No-Bend Warranty



AVAILABLE IN MATTE NERO AND PINK

Primal Safety Squat Bar Black  
Primal Safety Squat Bar Pink

5060492991656  
5060492992868

PSBA0012  
PSBA0023

230cm Olympic Deadlift Bar

5060492994879

PSBA0037

Commercial Multi Grip Olympic Shrug Bar Matte Nero

5060492990246

PSBA0001

Russian 28mm Olympic Bar & Collars

5060492994411

PSBA0031

Open Hex Trap Bar

5060492996385

PSBA0040



# "IT'S HEAVY" DUAL OLYMPIC 8 NEEDLE CERAMIC BAR

- > 8- Needle Bearings and Brass Centre Bearing
- > 1000kg machine-tested
- > Dual Knurl Markings at 1.2mm
- > 28mm grip with medium to good whip
- > 3 Year No Bend Warranty

"It's Heavy" Dual Olympic 8 Needle Black Bar  
 "It's Heavy" Dual Olympic 8 Needle Yellow Bar  
 "It's Heavy" Dual Olympic 8 Needle Blue Bar  
 "It's Heavy" Dual Olympic 8 Needle Red Bar  
 "It's Heavy" Dual Olympic 8 Needle Army Green Bar  
 "It's Heavy" Dual Olympic 8 Needle Camouflage Bar  
 "It's Heavy" Dual Olympic 8 Needle Ionised Black

5060492990161 PSBA0002  
 5060492990161 PSBA0025  
 5060492990161 PSBA0018  
 5060492990161 PSBA0020  
 5060492990161 PSBA0019  
 5060492993841 PSBA0026  
 5060492993100 PSBA0024

"Linda" Pink Olympic 15kg Bar  
 Ladies "Linda" Olympic 25mm 15kg Technique Bar

5060492992790 PSBA0021  
 5060492992790 PSBA0008

**PRIMAL  
STRENGTH**

## "AUSTIN" TEXAS POWER BAR

- > 29mm Grip, Olympic Power Bar
- > 190,000 PSI-Tested, 1500 lb-Rated
- > High-Tensile, Black Ionised-Steel Centre Bar
- > Steel 50mm Ends with Brass with no whip

## 7.5KG ALUMINIUM TECHNIQUE BAR

- > Perfect your Olympic lifts with this lightweight technique bar
- > Multiple Knurl Positions
- > No centre knurling
- > Shorter length
- > Also available in 10kg

## BE STRONG DUAL 4 NEEDLE OLYMPIC BAR

- > Minimum 190,000 PSI Tested, 1000lb Rated, High-Tensile Steel Olympic Bar
- > 28mm Multi-Knurl Heavy-duty Bar
- > Ionised Black Bar with Snap-Ring End
- > Calibrated weight to be accurate to within +/-0.5%

Primal Safety Squat Bar Black  
 Primal Safety Squat Bar Pink

5060492991656  
 5060492992868

PSBA0012  
 PSBA0023

Primal Strength Austin Texas Power Bar

5060492992844

PSBA0009

Primal Strength 7ft Black Olympic bar

5060492991649

PSBA0011

Olympic 7ft Matte Nero Bar, 4 Needle Bush Bearings

5060492990192

PSBA0005

230cm Olympic Deadlift Bar

5060492994879

PSBA0037

7.5kg Aluminium Technique Bar  
 10kg Aluminium Technique Bar

5060492994435  
 5060492994442

PSBA0033  
 PSBA0034



# HIP THRUST BAR

- > Exclusive rotational height adjustment mechanism sets the bar at the correct height - no more awkward shuffling up the bench to get into position!
- > High density foam padding for ultimate comfort even at maximal loading.
- > Integrated band pegs for maximum overload in the fully contracted position of the glutes.
- > Three height adjustments to perfectly fit different height benches.
- > Roller wheel balancing stems let you set up hip thrusts in seconds AND perform band assisted glute ham work like Nordic curls.

Hip Thrust Bar 5060492997016 PSBA0042

OLYMPIC BARS & COLLARS



## METAL QUICK RELEASE LOCK COLLAR

- > Sold in pairs
- > Our latest Metal Quick Release Lock Collars
- > Perfect for 50mm Olympic Bars
- > Quick Release Collars
- > Rubber Inserts to Ensure Zero Movement
- > Range of 4 Colours



## OLYMPIC LOCK STYLE COLLARS

- > Safety Latch to Secure Collars in Place
- > Stronger Grip than Spring Collars
- > 2-Year Commercial Warranty

Aluminium Lockjaw Collar Black	5060492994299	PSBA0027
Aluminium Lockjaw Collar Red	5060492994305	PSBA0028
Aluminium Lockjaw Collar Blue	5060492994312	PSBA0029
Aluminium Lockjaw Collar Green	5060492994329	PSBA0030
Olympic Fitness Lock Style Collars	5060492990208	PSBA0006

CONTACT OUR SALES TEAM ON [SALES@PRIMALSTRENGTH.COM](mailto:SALES@PRIMALSTRENGTH.COM) 0800 689 4021 (OPTION 2) [PRIMALSTRENGTH.COM](http://PRIMALSTRENGTH.COM)



# OLYMPIC DISCS & BUMPER PLATES

Primal Strength have a wide range of specialist bumper and Olympic plates. Including Urethane, Hi-Temp, Rubber and Calibrated Steel. The bumpers are competition colour coded and are individually weight tested to ensure they are highly accurate. The bumpers are drop tested thousands of times to ensure the bumper plate will stand the test of time in the toughest gyms performance centres or boxes.

OLYMPIC DISCS & BUMPER PLATES

## PREMIUM RUBBER OLYMPIC DISC WITH STAINLESS STEEL RING

- > Available from 1.25kg to 25kg
- > Tri-Grip Handles with Anti-Roll Disc-Edge Design
- > 2-Year Commercial Warranty



1.25kg	5060492991069	PSWD0001
2.5kg	5060492991076	PSWD0002
5kg	5060492991090	PSWD0003
10kg	5060492991106	PSWD0004
15kg	5060492991113	PSWD0005
20kg	5060492990307	PSWD0006
25kg	5060492991120	PSWD0007

## URETHANE OLYMPIC DISCS

- > Premium Urethane Finish
- > Brushed Steel Inserts
- > 1.25-25kg Range
- > Thinner Plates, Perfect for Plate Loaded Machines
- > 3-Year Full Commercial Warranty



1.25kg	5060492996767	PSWD9125
2.5kg	5060492996774	PSWD9205
5kg	5060492996781	PSWD9005
10kg	5060492996798	PSWD9010
15kg	5060492996804	PSWD9015
20kg	5060492996811	PSWD9020
25kg	5060492996828	PSWD9025

CONTACT OUR SALES TEAM ON [SALES@PRIMALSTRENGTH.COM](mailto:SALES@PRIMALSTRENGTH.COM) 0800 689 4021 (OPTION 2) [PRIMALSTRENGTH.COM](http://PRIMALSTRENGTH.COM)



## STEEL CALIBRATED PLATES

- > Machine calibrated to within +/- 10 grams
- > Raised lip around the edges allow for ease of lifting and transporting
- > Calibration plugs on back of plates for increased precision
- > 50mm collar opening for a snug fit.
- > Thin Design for 700+ KG bar loaded capacity
- > 3-Year commercial no break, excluding paint

0.25kg	5060492995944	PSWD0109
0.5kg	5060492995951	PSWD0110
1.25kg	5060492995968	PSWD0111
2.5kg	5060492995975	PSWD0112
5kg	5060492995982	PSWD0113
10kg	5060492995999	PSWD0114
15kg	5060492996002	PSWD0115
20kg	5060492996019	PSWD0116
25kg	5060492996026	PSWD0117
50kg	5060492996033	PSWD0118



## COMPETITION COLOUR BUMPER

- > Colour coded to Olympic weightlifting specification
- > Raised lip around the edges allow for ease of lifting and transporting
- > Calibrated steel three piece centre with lock bolts
- > 3-Year commercial warranty

10kg	5060492994725	PSWD0105
15kg	5060492994732	PSWD0106
20kg	5060492994749	PSWD0107
25kg	5060492994756	PSWD0108



# OLYMPIC COLOURED BUMPER PLATES

- > Brushed Steel, Rounded-Centre 50mm Holes
- > Range from 5 to 25kg in Olympic Lifting Colours
- > 2-Year Commercial Warranty

5kg Grey	5060492991045	PSWD0023
10kg Green	5060492990253	PSWD0024
15kg Yellow	5060492990260	PSWD0025

20kg Blue	5060492990277	PSWD0026
25kg Red	5060492990284	PSWD0027



## SET OF PRECISION CHROME MICRO/CHANGE PLATES

- > 4 Pair Micro Plate Set
- > 0.25-1kg Increments
- > Calibrated Stainless Steel
- > Laser-Engraved
- > 3-Year Commercial Warranty

Set Of Precision Chrome Micro/Change Plates 5060492991830 PSWD0219



## HI-TEMP FLECK GRAIN BUMPER PLATE

- > Hi-Temp Olympic Bumper Plate with Colour Fleck
- > Brushed-Steel, Enclosed, Rounded-Centre 50mm Holes
- > Tested to Under 2% Tolerance of Displayed Weight
- > High Bounce to Protect Bars and Floors
- > 2-Year Full Commercial Warranty

Pink Fleck 2.5kg	5060492991953	PSWD0124
Grey Fleck 5kg	5060492991960	PSWD0125
Green Fleck 10kg	5060492991977	PSWD0126
Yellow Fleck 15kg	5060492991984	PSWD0127
Blue Fleck 20kg	5060492991991	PSWD0128
Red Fleck 25kg	5060492992004	PSWD0129



## ELITE PU COMPETITION BUMPER PLATES

- > Machined-Steel Core Calibrated to Under 5g Tolerance
- > 450mm IWF Standard Diameter, 50mm centre
- > High-Durometer Premium Urethane Bumpers
- > Olympic Colour System That Will Never Fade
- > 3-Year Full Commercial Warranty

5kg Grey	5060492991045	PSWD0119
10kg Green	5060492990253	PSWD0120
15kg Yellow	5060492990260	PSWD0121
20kg Blue	5060492990277	PSWD0122
25kg Red	5060492990284	PSWD0123



# PREMIUM FIXED DUMBBELLS & BARBELLS

Primal Strength design and manufacture the widest range of dumbbells and barbells available.

We offer Rubber Hex Dumbbells with chromed ergo handles. Our Premium Dumbbells include; Rubber, Urethane and Custom Steel, all with with ionised black steel handles. Our steel dumbbells come with a lifetime guarantee.

The Primal Strength barbells come in both EZ and straight bar styles.

FIXED DUMBBELLS & BARBELLS

# URETHANE DUMBBELLS

- > 30mm Black-Ionised - 45% Stainless Steel
- > Sold in four sets ranging from 2kg-70kg
- > 3-Year Full Commercial Warranty

Primal Strength Urethane Dumbbell Set 2-10kg (10 Pairs)	5060492996729	PSWD0298
Primal Strength Urethane Dumbbell Set 2.5-25kg (10 pairs)	5060492996736	PSWD9225
Primal Strength Urethane Dumbbell Set 27.5-50kg (10 Pairs)	5060492996743	PSWD9226
Primal Strength Urethane Dumbbell Set 52.5-70kg (8 Pairs)	5060492996750	PSWD9227

CONTACT OUR SALES TEAM ON [SALES@PRIMALSTRENGTH.COM](mailto:SALES@PRIMALSTRENGTH.COM) 📞 0800 689 4021 (OPTION 2) [PRIMALSTRENGTH.COM](http://PRIMALSTRENGTH.COM)

# PREMIUM RUBBER STAINLESS STEEL HANDLE DUMBBELLS

- > 30 Thick, Black-Ionised Centres, 45% Stainless-Steel handles
- > Sold in pairs from 2.5kg to 70kg
- > 2-Year Full Commercial Warranty

2.5kg	PSWD0029	22.5kg	PSWD0037	47.5kg	PSWD0047
5kg	PSWD0030	25kg	PSWD0038	50kg	PSWD0048
7.5kg	PSWD0031	27.5kg	PSWD0039	52.5kg	PSWD0279
10kg	PSWD0032	30kg	PSWD0040	55kg	PSWD0221
12.5kg	PSWD0033	32.5kg	PSWD0041	57.5kg	PSWD0280
15kg	PSWD0034	35kg	PSWD0042	60kg	PSWD0222
17.5kg	PSWD0035	37.5kg	PSWD0043	62.5kg	PSWD0281
20kg	PSWD0036	40kg	PSWD0044	65kg	PSWD0282
22.5kg	PSWD0037	42.5kg	PSWD0045	67.5kg	PSWD0283
25kg	PSWD0038	45kg	PSWD0046	70kg	PSWD0284

Commercial Premium Rubber/  
Stainless Steel 2.5kg-25kg  
Dumbbell Set (10 Pairs) 5060492990338 PSWD0009

Commercial Premium Rubber/  
Stainless Steel 27.5kg-50kg  
Dumbbell Set (10 Pairs) 5060492990345 PSWD0008



## RUBBER HEX DUMBBELLS

- > Heavy-duty rubber encased heads
- > Easy-grip hardened chrome, ergonomic handles
- > Solid in pairs of dumbbells ranging from 1kg to 50kg
- > 1 Year Full Commercial warranty

1kg	PSWD0075	12.5kg	PSWD0085	42.5kg	PSWD0227
2kg	PSWD0076	15kg	PSWD0086	45kg	PSWD0228
2.5kg	PSWD0231	17.5kg	PSWD0087	47.5kg	PSWD0229
3kg	PSWD0077	20kg	PSWD0088	50kg	PSWD0230
4kg	PSWD0078	22.5kg	PSWD0089	42.5kg	PSWD0227
5kg	PSWD0079	25kg	PSWD0090	45kg	PSWD0228
6kg	PSWD0080	27.5kg	PSWD0091	47.5kg	PSWD0229
7kg	PSWD0081	30kg	PSWD0092	50kg	PSWD0230
7.5kg	PSWD0093	32.5kg	PSWD0223		
8kg	PSWD0082	35kg	PSWD0224		
9kg	PSWD0083	37.5kg	PSWD0225		
10kg	PSWD0084	40kg	PSWD0226		

## PREMIUM RUBBER STAINLESS STEEL HANDLE BARBELL SETS

- > 30mm Thick, Black-Ionised Centre, 45% Stainless-Steel, EZ Barbell Handles or Straight Bar
- > 10kg to 45kg, 10-Pair Set, with Matching Nero Dumbbell Sets
- > 2-Year Full Commercial Warranty

Premium Rubber Nero EZ  
Barbell Set 10-45kg 10 5060492991533 PSWD0028  
Pair Set

Premium Rubber Nero  
Barbell Set 10-45kg 10 Pair Set straight bar 5060492991533 PSWD0232





# CUSTOM STEEL DUMBBELLS

- > Hardened, Milled Steel, Ensuring Smaller Dumbbell Ends
- > 35mm, 1.2mm knurl, Ionised Black handles
- > Lifetime No Break Warranty
- > 2/3/4 custom end plates for Full Colour Logo or Primal Logo
- > Available in weights from 3kg up to 120kg
- > Optional Spinning Handles Available in 35mm Grip

Custom Steel Dumbbell Set 4-40kg (2kg increments 35mm handle) 20 pairs 2 sets of 10 kg pairs	5060492996699	PSWD0191
Custom Steel Dumbbell Set [3-25kg]	5060492996705	PSWD0192
Custom Steel Dumbbell Set 3-50kg (20 pairs )	5060492996712	PSWD0193

**INDIVIDUAL SIZES AVAILABLE FROM 3KG TO 120KG, CONTACT OUR SALES TEAM FOR A CUSTOM QUOTE**

FIXED DUMBBELLS & BARBELLS



## 10 PAIR DUMBBELL RACK

- > Matte Black 10-Pair Pro Dumbbell Rack
- > Heavy-Duty Design Holds up to 50KG Pro Dumbbells
- > 2 Year Commercial Warranty



## PREMIUM BARBELL RACK

- > Matte Black Pro Barbell Rack
- > Heavy-Duty Design Holds up to 10 x 50kg Pro Barbells
- > 2-Year Commercial Warranty

## HORIZONTAL HEX DUMBBELL RACK

- > Matte Black 10-Pair Hex Dumbbell Rack
- > Heavy-Duty Design Holds up to 30kg Hex Dumbbells
- > Two-Year Commercial Warranty



## 3 TIER DUMBBELL RACK

- > Matte Black 3-TIER Dumbbell Rack
- > Two-Year Commercial Warranty
- > Holds 15 pairs, max weight 50kg



## 6 & 10 PAIR UPRIGHT DUMBBELL RACK

- > Upright 10-Pair Hex Dumbbell Rack
- > Two-Year Commercial Warranty

Commercial 10 Pair Dumbbell Rack	5060492990420	PSST0003
Premium Barbell Rack	5060492991540	PSST0005
6 Pair Commercial Upright Dumbbell Rack	5060492994053	PSST0020
10 Pair Commercial Upright Dumbbell Rack	5060492991441	PSST0009
10 Pair Commercial Horizontal Hex Dumbbell Rack	5060492991458	PSST0010
3 Tier Dumbbell Rack	5060492994855	PSST0018

CONTACT OUR SALES TEAM ON [SALES@PRIMALSTRENGTH.COM](mailto:SALES@PRIMALSTRENGTH.COM) 📞 0800 689 4021 (OPTION 2) [PRIMALSTRENGTH.COM](https://www.primalstrength.com)





# FUNCTIONAL ACCESSORIES

No gym is complete without a range of functional accessories. From our unique 3-in-1 Foam Roller to our Primal Strength Plyo Boxes, we have designed a full range of premium commercial accessories to complete your facility.

FUNCTIONAL ACCESSORIES



## MINI BANDS

- > Set of 3
- > 55cm circumference by 3cm depth
- > 1mm (1.5kg resistance), 1.2mm (17.5kg resistance), 1.5mm (22.5kg resistance)
- > Can stretch to three times their size



## POWERBANDS

- > Four Sizes; 15mm, 30mm, 45mm, 65mm
- > Colour-Coded, Premium, Layered-Latex Rubber
- > Designed for Stretching, Strength & Power Training
- > 1-Year Commercial Warranty

15mm Red	PSAC0026	32mm Purple	PSAC0028
22mm Black	PSAC0027	42mm Green	PSAC0029



## OLYMPIC CHAINS 30KG PAIR

- > 15kg Weight Per Chain
- > Extended 1.83cm Length, Suitable for Squatting
- > Durable, Zinc-Coated Chain for Indoor and Outdoor Use
- > 1-Year Commercial Warranty



## MATERIAL GLUTE BAND

- > Available in four strength from 100lb - 200lbs
- > Comfortable Elasticised Fabric
- > Non Slip Rubber Strip
- > Colour coded

Olympic Chains 30kg Pair	5060492991182	PSAC0032	Black	PSAC0305	Red	PSAC0307
Mini Bands	5060492993698	PSPA0040	Grey	PSAC0306	Blue	PSAC0308

CONTACT OUR SALES TEAM ON [SALES@PRIMALSTRENGTH.COM](mailto:SALES@PRIMALSTRENGTH.COM) 0800 689 4021 (OPTION 2) [PRIMALSTRENGTH.COM](http://PRIMALSTRENGTH.COM)

# PREMIUM CAST KETTLEBELLS

The Premium Cast Kettlebells are completely different from a standard cast kettlebell. The kettlebells use a single one-piece design, are completely flawless and only use high quality iron. The kettlebells are coloured both on the base of the handle and main body colour for ease of selection in the gym and also have a flat base for safety.

FUNCTIONAL ACCESSORIES



## PREMIUM CAST KETTLEBELLS

- > Colour-Coded Handles and Numbers
- > Available in weights from 4kg to 40kg
- > Wide, Flat Base for Ease of Use and Storage
- > 2-Year Commercial Warranty

4kg	PSW00102	20kg	PSW00014
6kg	PSW00103	24kg	PSW00015
8kg	PSW00011	28kg	PSW00016
10kg	PSW00104	32kg	PSW00205
12kg	PSW00012	36kg	PSW00206
16kg	PSW00013	40kg	PSW00207



### KETTLEBELL RACK

- > Unique Multi-Step Design
- > Designed for the Rebel Commercial Fitness Premium Cast Kettlebells
- > 2 Year Commercial Warranty

Commercial Kettlebell Rack 5060492990239 PSS0002

CONTACT OUR SALES TEAM ON [SALES@PRIMALSTRENGTH.COM](mailto:SALES@PRIMALSTRENGTH.COM) 0800 689 4021 (OPTION 2) [PRIMALSTRENGTH.COM](http://PRIMALSTRENGTH.COM)





## FITNESS FOAM ROLLER

- > Firm, High-Density Foam Roller
- > PVC, Dense Internal Structure
- > Multi-Design Trigger Points
- > 100kg Rated
- > 1-Year Commercial Warranty



## CAMOUFLAGE FOAM ROLLER

- > Firm, High-Density Foam Roller
- > PVC, Dense Internal Structure
- > Multi-Design Trigger Points
- > 100kg Rated
- > 1-Year Commercial Warranty



## FITNESS LADDERS

- > Heavy-Duty Extended 10m Speed Ladder Set
- > 20 Rung, Flat, Plastic Ladders at 50cm Wide
- > Durable Plastic Ladders with Double-Stitched Nylon Sides
- > 1-Year Commercial Warranty



## FITNESS HURDLES

- > Metal, 1-Piece Hurdles
- > 4 Hurdles Per Set
- > Increasing Heights: 15cm/22.5cm/30cm/45cm
- > Perfect for Speed and Agility Training
- > 1-Year Indoor & Outdoor Commercial Warranty



## 3-IN-1 FOAM ROLLER SET

- > 4cm by 45cm Massage Stick
- > 10cm by 45cm Medium Foam Roller
- > 16cm by 45.5cm Firm Foam Roller
- > 3-in-1 Space-Saving Design
- > 1-Year Home Warranty

Fitness Ladders 5060492991144 PSAC0007

Fitness Hurdles 5060492991175 PSAC0008

Fitness Foam Roller 5060492991571 PSAC0025

Camouflage Foam Roller 5060492995135 PSAC0146

3-in-1 Foam Roller Set 5060492991069 PSAC0024



# ANTI-BURST SLAM BALLS

- > Dimpled rubber exterior offering more grip and protection for the slam ball
- > Range of slam balls from 3kg to 70kg
- > Anti-Burst design allows balls to be slammed from overhead
- > 10,000 times drop tested between 1-4m height
- > 12 months Commercial Warranty\*

3kg	PSAC0114	15kg	PSAC0149	45kg	PSAC0155
5kg	PSAC0010	20kg	PSAC0150	50kg	PSAC0156
6kg	PSAC0115	25kg	PSAC0151	55kg	PSAC0157
7kg	PSAC0309	30kg	PSAC0152	60kg	PSAC0158
9kg	PSAC0116	35kg	PSAC0153	65kg	PSAC0159
10kg	PSAC0148	40kg	PSAC0154	70kg	PSAC0160



# CAMOUFLAGE SANDBAGS

- > Heavy-Duty, Non-Rip Design
- > Range from 5kg to 30kg/kg
- > Designed with an Optional, 4-Level Storage Rack
- > 1-Year Full Commercial Warranty

5kg Grey	5060492994275	PSAC0030
10kg Yellow	5060492990444	PSAC0003
15kg Green	5060492990451	PSAC0004
20kg Blue	5060492990468	PSAC0005
25kg Red	5060492991151	PSAC0006
30kg Black	5060492994282	PSAC0031

## SANDBAG STAND

- > Small Foot Print for Studios & PT Spaces
- > Designed for the Camouflage Sandbags
- > 2-Year Commercial Warranty

Commercial Sandbag Stand	5060492991168	PSST0004
--------------------------	---------------	----------



## PARALLETTE

- > Ideal for anyone with an interest in CrossFit, gymnastics, street workout, calisthenics, resistance training
- > 12" clearance area
- > Made from heavy-duty tubing



## AB MAT

- > Premium Sweat Resistant Vinyl Cover
- > Standard AbMat Size/Design
- > Lightweight Portable Unit
- > One Years parts Warranty



## GYM RINGS

- > Ideal for CrossFit Boxes and use on Rigs
- > 23cm Pair of Gym Rings
- > Heavy-Duty Nylon Straps
- > Adjustable Numbered Straps with Secure Chrome Clasps
- > 1-Year Commercial Warranty

Fitness Ab Slings	5060492991557	PSAC0022
Gym Rings	5060492990321	PSAC0023
Parallette	5060492995029	PSAC0136
Ab Mat	5060492995012	PSMA0029



## COMMERCIAL 10M AND 15M BATTLE ROPES

- > Premium-Grade, Canvas-Covered Battle Rope
- > 10m and 15m Long with 38mm Rubberised Grip Handles
- > 10m is 12kg and 15m is 15kg in weight, Ideal for a variety of Conditioning Exercises
- > Designed to be Used in Gyms and Outdoors
- > 1-Year Full Commercial Warranty



## AB SLING

- > Pair of Ab Slings with Stainless Steel, Carabiner Clips
- > Brushed-Fabric, Padded Centres
- > 100kg-Rated, Heavy-Duty Stitching & Canvas Outer
- > Can be Attached to Any Bar or Rack
- > 1-Year Home Warranty

15m Commercial Battle Rope	5060492991199	PSAC0009
10m Commercial Battle Rope	5060492994862	PSAC0129



## COMMERCIAL PU PLYO BOX

- > Heavy-Duty PU Canvas
- > Wooden Centre Box for Stability
- > 50/60/75cm Heights
- > Commercial Warranty

Commercial PU Plyo Box    5060492991687    PSAC0103



### WOODEN PLYO BOX

- > Multi-Height Commercial, Wooden Plyo Box
- > Standard Sizes - 50cm, 60cm, and 75cm Heights
- > Reinforced Centre for Extra Durability
- > 1-Year Commercial Warranty



### COMMERCIAL PU PLYO BOX

- > Heavy-Duty PU Canvas
- > Wooden Centre Box for Stability
- > 50/60/75cm Heights
- > Commercial Warranty



### FOAM PLYO BOX SET

- > Durable heavy-duty high density foam
- > Heavy-duty velcro fastening attachments
- > 5 stackable platforms
- > Non-slip surface
- > Large landing area

Wooden Plyo Box	5060492990437	PSAC0002
Foam Plyo Box Set	5060492994992	PSAC0134
Commercial PU Plyo Box	5060492991687	PSAC0103

# GLS DOUBLEBELL

- > DoubleBells™ are a double handled resistance training tool designed to maximise training variety whilst using a single implement
- > Identical dimensions from 10kg to 30kg in weight
- > Tubular steel construction; no cast iron used
- > DoublebellStand available

10kg	PSWD0049	25kg	PSWD0052
15kg	PSWD0050	30kg	PSWD0053
20kg	PSWD0051		



## DOUBLEBELL STAND

- > Small Foot Print for Studios & PT Spaces
- > Designed for the GLS Doublebells
- > 2-Year Commercial Warranty

Commercial Doublebell Stand 5060492996392 PSST0023

FUNCTIONAL ACCESSORIES



## 20KG CAMOUFLAGE WEIGHTED VEST

- > 20kg Weighted Vest
- > Hardwearing Brushed Canvas
- > Oversized Velcro Strap
- > Ten 2kg Weights, Total 20kg
- > 1-Year Commercial Warranty



## WALL BALL DIGITAL CAMOUFLAGE

- > Digital Camouflage Design
- > Double-Stitched PU Canvas Outer
- > 3-13kg Range in 1KG Increments
- > Perfect for Circuits & Conditioning
- > 1-Year Commercial Warranty



## STEEL SPEED ROPE

- > Lightweight Steel Handles
- > Firm Knurling With laser Cut Primal Strength Logo
- > Adjustable Length
- > Smooth Swivel Bearing

3kg 5060492991724 PSWD0208

4kg 5060492991731 PSWD0209

5kg 5060492991748 PSWD0210

6kg 5060492991755 PSWD0211

7kg 5060492991762 PSWD0212

8kg 5060492991779 PSWD0213

9kg 5060492991786 PSWD0214

10kg 5060492991793 PSWD0215

11kg 5060492991809 PSWD0216

12kg 5060492991816 PSWD0217

13kg 5060492991823 PSWD0218

Commercial 20kg  
Camouflage Weighted vest 5060492991847 PSWD0220

Steel Speed Rope 5060492995005 PSAC0135

CONTACT OUR SALES TEAM ON [SALES@PRIMALSTRENGTH.COM](mailto:SALES@PRIMALSTRENGTH.COM) 0800 689 4021 (OPTION 2) PRIMALSTRENGTH.COM





COMMERCIAL

# PREMIUM PROWLER

- > Karabiner Attachments for Harness
- > Olympic-Sized Poles for Pushing Exercises and Loading Olympic Discs
- > Powder-Coated, Commercial Grade 11 Gauge/3mm Steel
- > 3 Oversized Footplates Ensuring Smoother Pushing Motion

Commercial Premium Prowler 5060492991205 PSSS0015

FUNCTIONAL ACCESSORIES



## PROWLER DOG SLED WITH HARNESS

- > Lifetime Frame & 1-Year Commercial Parts Warranty
- > One Piece Welded Dog Sled
- > Heavy-duty 6mm Steel
- > Two Removal Upright Push Poles
- > Detachable Harness Included



## COMMERCIAL PREMIUM PROWLER SLED

- > Multi-Handle, Rubber Grip System
- > Karabiner Attachments for Harness
- > Olympic-Sized Poles for Pushing Exercises and Loading Olympic Discs
- > Powder-Coated, Commercial Grade 11 Gauge/3mm Steel
- > 3 Oversized Footplates Ensuring Smoother Pushing Motion
- > Detachable Harness Included

## FITNESS HARNESS

- > Dual, Stainless Steel, Carabiner Clips Connect to the Primal Strength Stealth Prowler
- > Single Nylon Straps Connect to Each Side of the Body Harness
- > Can be Used for Speed and Power Work
- > 1-Year Home and 90-day Commercial Warranty

Commercial Premium Prowler Sled	5060492991205	PSSS0015
Fitness Harness	5060492990871	PSAC0033
Prowler Dog Sled with Harness	5060492994978	PSSS0074

CONTACT OUR SALES TEAM ON [SALES@PRIMALSTRENGTH.COM](mailto:SALES@PRIMALSTRENGTH.COM) 0800 689 4021 (OPTION 2) PRIMALSTRENGTH.COM

# DOUBLE HANDLE MEDICINE BALLS

- > Premium Rubber Medicine Balls
- > Fully Colour Coded with Large Weight Badge
- > Perfect for a Wide range of Exercises
- > One Year Commercial Warranty

3kg	PSAC0138	8kg	PSAC0143
4kg	PSAC0139	9kg	PSAC0144
5kg	PSAC0140	10kg	PSAC0145
6kg	PSAC0141		
7kg	PSAC0142		

## MEDICINE BALL STAND

- > Small Foot Print for Studios & PT Spaces
- > Designed for the Double Handle Medicine Balls
- > 2-Year Commercial Warranty

Commercial Medicine Ball Stand 5060492995128 PSST0022

FUNCTIONAL ACCESSORIES



### COMMERCIAL FARMER WALK HANDLES

- > One-Piece Farms Walk Handles (2 Per Set)
- > Fully Welded Frame & Handle
- > Aggressive Knurl on Handles
- > Long Load Pins



### FULL DEADLIFT BAR JACK

- > Perfect to Lift Any Bar to Remove Plates
- > Welded Base Frame
- > Rubberised Handle



### SQUAT RAMPS

- > Improve Your Squat Range
- > Fully Welded Pair of Steel Squat Ramps
- > Available in 10/20/30 Degree Angles
- > Lifetime Warranty

10 Degree	PSAC0118	30 Degree	PSAC0120
20 Degree	PSAC0119		

Commercial Farmer Walk Handles	5060492994718	PSBA0036
Full Deadlift Bar Jack	5060492994954	PSBA0039
Commercial Jerk Blocks	5060492994695	PSAC0121



### COMMERCIAL JERK BLOCKS

- > Complete set with four heights available
- > Top layer with stoppers to prevent roll off
- > Re-inforced plywood construction
- > Handles for easy movement





Fitness-Mad have you covered when it comes to fitness equipment, we pride ourselves on our high-quality equipment which is ideal for studio, clubs, gyms, as well as fitness instructors, personal trainers or for home and private use.



## STUDIO PRO 500KG SWISS BALL & PUMP

- > Our Studio Pro Ball is rated at a massive 500Kg and is one of the toughest balls available
- > Extensively tested by SGS Laboratories for burst-resistance and static loading
- > Perfect for weight training, Fit Ball workouts, Yoga, Pilates or physiotherapy
- > Boxed complete with blaster pump

55cm FBALLSP55K

65cm FBALLSP65K

75cm FBALLSP75K

## CLUB AEROBIC MAT EYELETS 9.5MM

- > Save space in your studio with the two-toned studio quality Club Aerobic Mat with Eyelets from Fitness-Mad.
- > EExtremely durable and has an antislip bottom
- > Dimensions - 100cm X 50cm x 9.5mm. Eyelet centre to centre 36.5cm. Eyelet dia 2.1mm.
- > The eyelets are 36.5cm apart [eyelet to eyelet] and each eyelet is 2.1mm diameter.



## EXERCISE MAT RACK

- > Keep your studio tidy with the Fitness-Mad Exercise Mat Rack for Core Fitness & Club Aerobic Eyelet Mat. Designed to hold mats with eyelets with a hole diameter greater than 2cm.
- > Perfect for use with - Core Fitness Mat 10mm with Eyelets, Core Fitness Mat 15mm with Eyelets or Club Aerobic Mat with Eyelets

Club Aerobic Mat Eyelets 9.5mm FAMATVINYL

Exercise Mat Rack FMATRACK



## PRO SUSPENSION TRAINER

- > Independently load tested to over 1000Lb [450Kgs] and built to perform from hi-strength polyester webbing with industrial bartack stitching.
- > Maximum User Weight - 125Kg



## STUDIO PRO REBOUNDER 40"

- > Commercial grade rebounder
- > Trampoline Weight - 10 kg
- > Dimensions - 40" diameter
- > Maximum user weight - 125kg



## AEROBIC STEP

- > Can be used for a range of exercises and classes
- > No assembly required, simply unpack and you're good to go
- > Additional risers available
- > Non-slip surface

Studio Pro Rebounder 40" FTRAMP40B

Aerobic Step FSTEP

Pro Suspension Trainer FSUSPTRAIN



## NEOPRENE DUMBBELLS 0.5-5KG

- > Perfect for at home workouts, gyms, clubs, studios, aerobics, HIIT and toning
- > Pair of Neoprene coated dumbbells
- > Flat bottoms prevent weights from rolling away
- > Rack available

0.5kg FDBELL05

1kg FDBELL1

1.5kg FDBELL1HALF

2kg FDBELL2

3kg FDBELL3

4kg FDBELL4

5kg FDBELL5

Optional Rack FDBELLRACK

# CABLE AND BARBELL ATTACHMENTS

Primal Strength design and manufacture a wide range of cable attachments. Our premium range of cable attachments are finished in a stunning black chrome finish, which truly sets your gym apart.

The Primal Strength Max Grip handles ensure your hand placements are ergonomically in the correct position for perfect muscle engagement.

To complete the range we offer a wide variety of collars and accessories.

CABLE AND BARBELL ATTACHMENTS



## BLACK LAT PULL DOWN BAR

- > Wide Lat Bar with 3 Grip Options
- > Knurled grip with Stopper ends
- > Oversized stopper-ends for Maximum Support When Using a Wide Grip
- > 1-Year Commercial Warranty



## BLACK REVOLVING V BAR

- > Knurled Grip with Stopper ends
- > Angled to Reduce Wrist Pressure when Pressing
- > Laser-Etched with Primal Strength Logo
- > 1-Year Commercial Warranty



## DOUBLE TRICEP ROPE

- > Laser-Etched, Hardened Chrome Centre
- > Oversized Rubber Stopper Ends
- > 1-Year Commercial Warranty



## BLACK REVOLVING DOUBLE HANDLE ATTACHMENT

- > Black-Chrome, Double-Handle, Close-Grip Attachment
- > Revolving Centre Reduces Stress on User's Wrist
- > Laser-Etched with Primal Strength Logo
- > 1-Year Commercial Warranty



## REVOLVING SINGLE TRICEP HANDLE

- > Revolving, Black-Chromed & Knurled Grip
- > Reduces Stress on Users Wrist
- > 1-Year Commercial Warranty



## BLACK REVOLVING STRAIGHT BAR

- > Knurled Ergo-Grip with ball ends
- > Revolving Bar Centre, Reduces Wrist Pressure when Pressing
- > 1-Year Commercial Warranty

Black Revolving Double Handle Attachment	5060492994794	PSAC0018
Black Lat Pull Down Bar	5060492994800	PSAC0126
Black Revolving V Bar	5060492994787	PSAC0124

Revolving Single Tricep Handle	5060492994770	PSAC0123
Double Tricep Rope	5060492990123	PSAC0015
Black Revolving Straight Bar	5060492994763	PSAC0122





## MAX GRIP HANDLES

- > Focus on muscle isolation
- > Ergonomically shaped to fit the hand
- > Non-slip coating
- > Angled to ease joint pain



## DOUBLE HANDLE LAT BAR

- > Vertical Wide Grip and Horizontal Close Grip
- > Revolving Bar Centre & Premium Rubber Ergo-Grips
- > Laser-Etched with Primal Strength Logo
- > 1-Year Commercial Warranty

## BLACK CURL BAR ATTACHMENT

- > Knurled Ergo-Grip with stopper ends
- > Revolving Bar Centre, Reduces Wrist Pressure when Pressing
- > 1-Year Commercial Warranty

Double Handle Lat Bar	5060492991489	PSAC0021
Max Grip Handles	5060492994626	PSAC0100
Black Curl Bar Attachment	5060492994817	PSAC0127

### CABLE AND BARBELL ATTACHMENTS

# GLS CRANE HANDLE

- > Change grip width in seconds, change grip angle during a set!
- > 4mm solid steel sheet construction
- > Ultra smooth bushes and rotor pin give low friction movement in every direction.
- > Precision Laser cut housing gives 5 different grip width options.
- > Supplied with Primal Strength stirrup style handles

GLS Crane Handle

PSAC0166



### 360 LANDMINE BARBELL ATTACHMENT

- > Helps maximise range of motion across lateral raises, one arm rows and multiple core exercises
- > Seamless sleeve ensures no scuffs or scratches to your barbell
- > Suitable for use with 2" Olympic bars
- > Rotating Chrome Handle
- > Black powder coated steel construction



### WISHBONE

- > The Wishbone adapts to you as opposed to you adapting to the rigid barbell
- > Allows natural flexion and extension of the ankles, knees and hips making it easy to learn!
- > Develop lower body functional size and strength
- > No weight sitting directly on your upper spine
- > No hyper extension of your shoulder



### STAND ALONE LANDMINE

- > 10mm Steel Base
- > Full 360 Range of Motion on Brass Bearing
- > Olympic Bar Holder
- > Can be Floor Mounted
- > Matte Black Powder Coat Finish

360 Landmine Barbell Attachment

5060492994923

PSAC0130

Stand Alone Landmine

5060492994961

PSAC0133

Wishbone

5060492994947

PSAC0132

#### CABLE AND BARBELL ATTACHMENTS

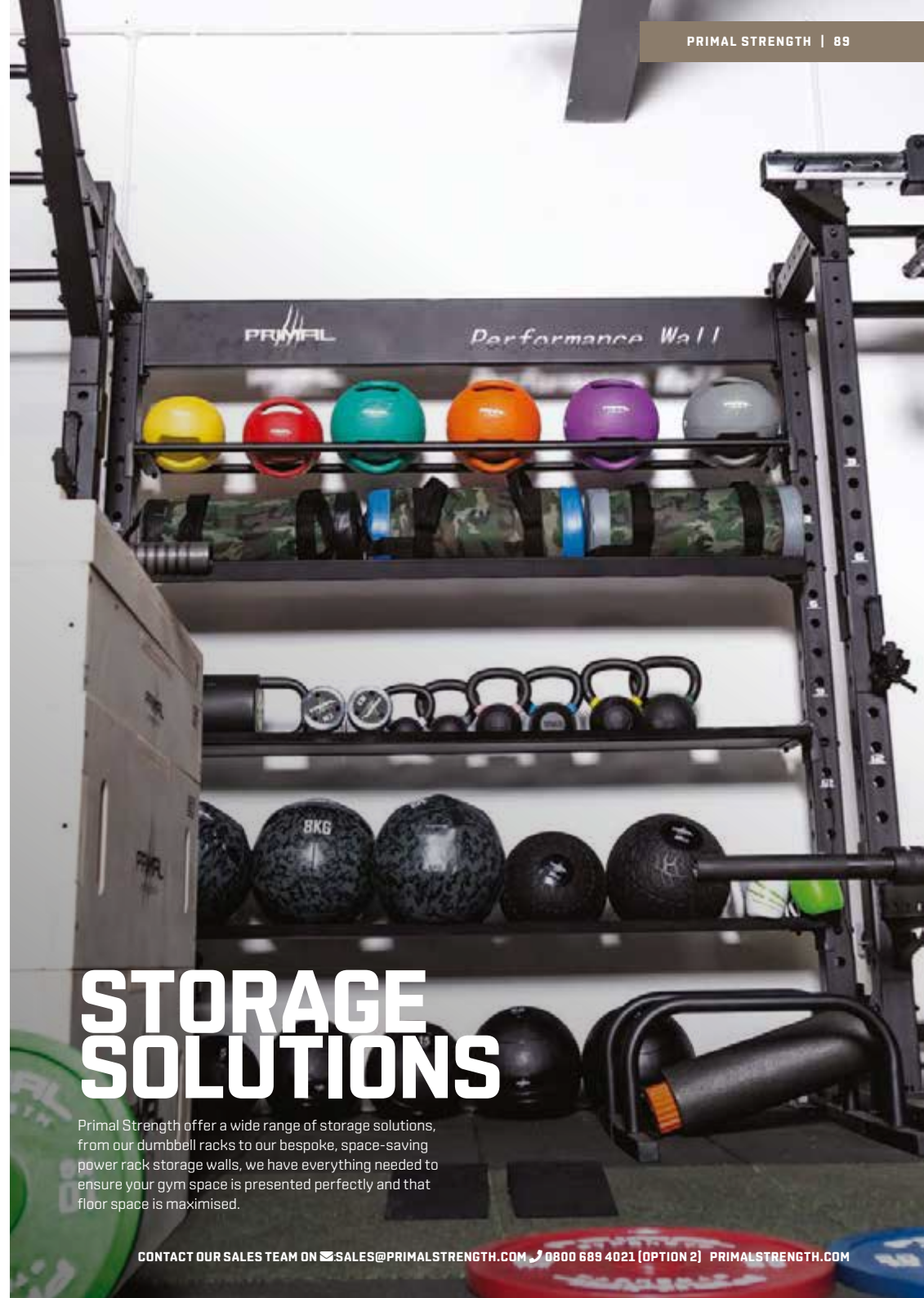

# STORAGE SOLUTIONS

Primal Strength offer a wide range of storage solutions, from our dumbbell racks to our bespoke, space-saving power rack storage walls, we have everything needed to ensure your gym space is presented perfectly and that floor space is maximised.

CONTACT OUR SALES TEAM ON [SALES@PRIMALSTRENGTH.COM](mailto:SALES@PRIMALSTRENGTH.COM) 0800 689 4021 (OPTION 2) [PRIMALSTRENGTH.COM](http://PRIMALSTRENGTH.COM)





COMMERCIAL  
**HORIZONTAL  
OLYMPIC BAR AND  
BUMPER HOLDER**

- > Holds 5 Olympic Bars
- > 4 Extended Bumper Plate Holders
- > 5 Micro Plate & Collar Holders
- > Free-Standing Horizontal Design
- > Lifetime Frame, 1-Year Commercial Warranty



**PREMIUM BARBELL  
RACK**

- > Heavy-Duty Design Holds up to 10 x 50kg Pro Barbells
- > Designed for the Commercial 10-Pair Barbell Set
- > 2-Year Commercial Warranty



**OLYMPIC DISC &  
BARBELL RACK**

- > Matte Black Multi-Olympic Bar & Disc Storage Unit
- > Holds 4 Olympic Bars
- > 7 Olympic Discs & Bumper-Plate Holders
- > 2-Year Commercial Warranty



**9 BAR FLOOR  
STORAGE RACK**

- > Each holder is coated to protect your bars
- > Stores 9 Olympic barbells safely
- > Heavy-duty base
- > Wide foot plate



**FREE STANDING  
WALL STORAGE**

- > Suitable for Wall Balls and Bumper Plates only
- > Heavy-duty Castor Lockable Wheels



**BUMPER PLATE TROLLEY**

- > Premium Steel construction
- > Lockable heavy-duty castor wheels
- > Raised edges allowing you to remove the plates with ease
- > Easy to move



**BUMPER PLATE RACK  
WITH WHEELS**

- > Store your Olympic weight plates safely and organised
- > Heavy-duty lockable castor wheels
- > Easy to move

Olympic Disc & Barbell Rack	5060492990222	PSST0001
Premium Barbell Rack	5060492991540	PSST0005
Commercial Horizontal Olympic Bar and Bumper holder	5060492991618	PSST0013

9 Bar Floor Storage Rack	5060492994909	PSST0021
Bumper Plate Trolley	5060492991540	PSST0015
Free Standing Wall Storage	5060492994688	PSST0016
Bumper Plate Rack with Wheels	5060492994893	PSST0019



## CENTRAL STORAGE

- > Compatible with V3 Half Racks, Performance Walls, Pt Pods or Monster Racks
- > Consists of rail, two flat shelves and an angled shelf
- > Available in 1.1m or 1.8m widths



## 6 BAR WALL MOUNTED RACK

- > Storage for 6 barbells
- > Made from heavy-duty steel
- > Rubber coated hooks to protect your bars



## MEDICINE BALL RACK

- > Storage for 8 medicine balls
- > Small Foot Print for Studios & PT Spaces
- > Suitable for commercial
- > 2-Year Commercial Warranty



## COMMERCIAL SANDBAG STAND

- > Matte Black Sandbag Stand
- > Small Foot Print for Studios & PT Spaces
- > Designed for the Camouflage Sand Bags
- > 2-Year Commercial Warranty

Medicine Ball Rack 5060492995128 PSST0022

6 Bar Wall Mounted Rack 5060492994701 PSST0017

Commercial Sandbag Stand 5060492991168 PSST0004

Central Storage 5060492994381 PSPR0033

### STORAGE SOLUTIONS



# WIDE RANGE OF CUSTOM GYM FLOORING AND TRACKS

Primal Strength offer a wide range of strength, cardio, studio and functional flooring solutions.

Our rubber flooring includes high-impact 20mm EPDM and SBR tiles. Sound deadening 40mm EPDM and SBR tiles. All available in a wide range of fleck and colour options. Our Studio and cardio gym floor solutions include 6-20mm Rubber rolls and AC5 grade wood-effect finishes.

The range is completed with both budget-friendly astro carpet through to urethane backed bespoke astro turf in any length or width.



COMMERCIAL  
**EPDM PREMIUM  
 GYM TILE**

- > 1 x 0.5m tiles, Premium Grey Fleck
- > Bonded corners and edges available
- > Available in thicknesses from 20mm to 40mm
- > 7-Year Full Commercial Warranty
- > Meets UK Fire and Smoke Emission Regulations
- > High-Impact, Slip Resistant
- > Sound Absorbing [40mm has sound dispersing circles]

20mm x 1m x 0.5m Tile	5060492996552	PSMA0408
20mm Ramped Edge	5060492996606	PSMA0413
20mm Corner Edge	5060492996613	PSMA0414
40mm x 1m x 0.5m Tile	5060492996569	PSMA0409
40mm Ramped Edge	5060492996583	PSMA0411
40mm Corner Edge	5060492996590	PSMA0412
Tile Connectors	5060492996576	PSMA0410

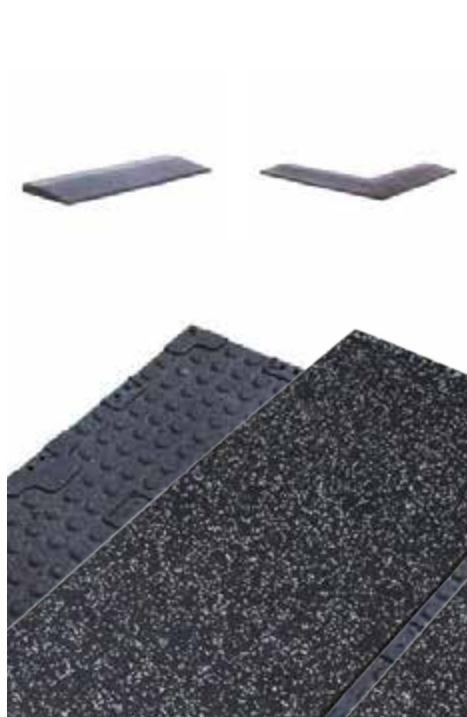

COMMERCIAL  
**GRADE GYM  
 FLOOR MATTING**

- > UK Manufactured, Recycled, Rubber Grain, Premium Black Gym Flooring
- > 3-Year Full Commercial Warranty
- > Odourless, New Moulds, available with or without the Primal Strength Logo

20mm Square	5060492992264	PSMA0001
20mm Square with Two Sided Corner	5060492992271	PSMA0002
20mm Square with One Edge Side	5060492992288	PSMA0003
40m Square	5060492993742	PSMA0004
40mm Square with Two Sided Corner	5060492993766	PSMA0005
40m Square with One Edge Side	5060492993773	PSMA0006
20m Square with Inverted corner		PSMA0007
1x1m Inverted Corner	5060492992219	PSMA0009



# PREMIUM ASTRO TRACK

- > Start and 1-11m Markings in White
- > Four Colourways
- > Lanes and track Markings
- > 20mm Astro Grass with Rubber Backing
- > Glues Directly to the Floor
- > 3 year Commercial Warranty

Green	5060492993865	PSMA0025
Black	5060492993872	PSMA0026
Red	5060492993889	PSMA0027
Blue	5060492993896	PSMA0028

MATTING & FLOORING

# CUSTOM ASTRO TRACK

- > Created with custom logo or markings
- > Available in any ten colour combination
- > Each track is made per order

Custom Astro Track

CUSTOM

CONTACT OUR SALES TEAM ON [SALES@PRIMALSTRENGTH.COM](mailto:SALES@PRIMALSTRENGTH.COM) 📞 0800 689 4021 (OPTION 2) [PRIMALSTRENGTH.COM](http://PRIMALSTRENGTH.COM)



# BESPOKE CUSTOM SERVICE

Primal Strength offer a wide range of customisable solutions.

We offer customised dumbbells in both urethane and steel. Customised urethane and rubber bumper plates.

You can add your brand to any pad with a bespoke sweat wrap, and complete your gym with branded turf, flooring and platforms.

We have a wide variety of rack and bench colours in stock and can offer our full range in any colour subject to lead times.

CUSTOM



## CUSTOM RIGS

- > Configured to your requirements
- > Powder-coated frame with custom colour available
- > Laser cut logos
- > Utilise your space with a rig that fits



## CUSTOM STEEL DUMBBELLS

- > Hardened, Milled Steel, Ensuring Smaller Dumbbell Ends
- > 35mm, 1.2mm knurl, Ionised Black handles
- > Lifetime No Break Warranty
- > 2/3/4 custom end plates for Full Colour Logo or Primal Logo
- > Available in weights from 3kg up to 120kg
- > Optional Spinning Handles Available in 35mm Grip



## CUSTOM PLATFORM INSERTS

- > Showcase your brand in full colour
- > Choice of 20mm, 30mm or 40mm
- > Dual or single branded
- > Heavy-duty non-slip clear coating
- > Fits in any of our platforms



## CUSTOM BENCH WRAPS

- > Full colour embroidered logo
- > Fits any of our V2 FID benches
- > Can be take off easily to clean
- > Fits any Primal Strength pad

# CURVED TREADMILL

- > Time/Distance/Peak Speed/ HR Recovery LCD Feedback
- > Wireless Heart Rate
- > Six Levels of Resistance
- > Two-Years Warranty

Curved Treadmill 5060492991465 PSTM0043

CARDIO



## INCLINE TRAINER HIITMILL

- > Self-powered walking, running, pushing & pulling
- > Magnetic resistance brake
- > Multi-grip hand positioning - high, mid and low options
- > Blue Backlit LCD Monitor
- > Portable design with oversized transport wheels and rear carry handle



## DUAL DRIVE HIIT AIRBIKE

- > Belt & Chain Driven for Unrivalled Smoothness
- > Heavy-Duty Oversized Frame & Handlebars
- > Adjustable Height and Distance Racing Seat
- > LCD Console with Intervals, Target; Distance, Kcals, HR
- > Dual Pedals

Incline Trainer HIITmill

5060492993650

PSTM0044

Dual Drive HIIT Airbike

5060492997238

PSEB0074

Commercial Grappler

PSSSGRAP



## COMMERCIAL GRAPPLER

- > 8 levels of resistance
- > Self Powered
- > The Ultimate Upper Body HIIT Machine
- > Continuous Rope Pull
- > Lifetime frame Warranty





**KEISER®**

## M3i LITE INDOOR BIKE

- > Bluetooth® wireless signal with open API for tablets and smartphones Wireless Heart Rate
- > V-shape frame to match riders from 4'10" to 7' tall and up to 350 lbs
- > Only drive-train specifically built for magnetic resistance with quiet, single Poly-V belt drive
- > Magnetic resistance for greater repeatability and reduced wear
- > Rearwheel design for protection from sweat and corrosion
- > Revolutionary redesigned Keiser Bike Pedal



CARDIO



**concept 2**

## CONCEPT 2 SKIERG WITH STAND

- > Free standing or wall mounted
- > PMS Monitor Included
- > Responsive Flywheel and Dampener to suit your preferred training style
- > Ergonomic Strapless Handles - suits all hand sizes, no adjustment needed
- > Easy to assemble
- > Stand sold separately

CONTACT OUR SALES TEAM ON [SALES@PRIMALSTRENGTH.COM](mailto:SALES@PRIMALSTRENGTH.COM) 📞 0800 689 4021 (OPTION 2) [PRIMALSTRENGTH.COM](http://PRIMALSTRENGTH.COM)



**concept 2**

## WITH EVERY CONCEPT 2 ROWER YOU GET:

- > The spiral damper allows you to easily adjust the airflow to the flywheel, so you can change the feel of the stroke. The flywheel design minimizes noise while maximizing a smooth feel
- > Adjustable Footrests and the ergonomic handle features a 10 degree bend that allows you to row with a natural arm and hand position

CARDIO



### CONCEPT 2 MODEL D PM5

- > PM5 Monitor provides accurate comparable data for every row
- > 14" [35.6 cm] seat height, the Model D keeps a low profile
- > The Model D features a quick-release (no tools required!) framelock mechanism, so you can easily separate the machine into two pieces for storage



### CONCEPT 2 MODEL E PM5

- > PM5 Monitor provides accurate comparable data for every row
- > The 20 inch [50.8 cm] seat height makes it easy to get on and off the rower
- > The Model E features a quick-release (no tools required!) framelock mechanism, so you can easily separate the machine into two pieces for storage. Caster wheels on the front foot allow you to roll the fully-assembled machine into position



### CONCEPT 2 BIKEERG

- > Durable construction that's easy to maintain
- > Lightweight and mobile
- > Adjustable saddle and handlebars
- > Bluetooth and ANT+ wireless connectivity
- > Fits most standard bike parts



### WATERROWER CLUB ROWING MACHINE WITH S4 PERFORMANCE MONITOR

- > Black and Rose Stain finished in Danish Oil
- > Constructed from sustainably sourced American Ash wood
- > S4 Performance Monitor



### WATERROWER M1 HIRISE ROWING MACHINE WITH S4 PERFORMANCE MONITOR

- > Frame is constructed from a fabricated tubular steel
- > S4 Performance monitor included



### WATERROWER M1 LORISE ROWING MACHINE WITH S4 PERFORMANCE MONITOR

- > Frame is constructed from a fabricated tubular steel
- > S4 Performance monitor included



**WaterRower**





### SPIRIT FITNESS CT800 TREADMILL

- > Large Blue-LED Matrix Window w/20-Character Message Centre, and 4 Separate LED Windows, with tablet Friendly Reading Rack Holder, convenient water bottle holder, and cargo compartment for keys, phone, or MP3 player.
- > 4HP Continuous Duty DC Drive Motor w/Grade H Insulation
- > 22" x 60", Habasit® Commercial, Multi-Ply Belt



### SPIRIT FITNESS CT850 TREADMILL

- > 4.0 hp continuous duty AC motor with Grade H insulation.
- > Large Red-LED Matrix Window w/20-Character Message Centre, and 4 Separate LED Windows, with tablet friendly reading rack holder, convenient water bottle holder, and cargo compartment for keys, phone, or MP3 player.
- > 22" x 60", Habasit® Commercial, Multi-Ply Belt



### SPIRIT FITNESS CT900 TREADMILL

- > Industrial, 5.0 horsepower AC drive system provides power and longevity.
- > Roomy 22" x 62" workout surface maximises movement in its footprint.
- > Double-sided phenolic deck, 3.0" rollers and multi-ply Habasit® belt provide smooth motion.



**SPIRIT**

### CT900 ENT TREADMILL WITH 15.6" TOUCHSCREEN

- > Industrial, 5.0 horsepower AC drive system provides power and longevity.
- > Roomy 22" x 62" workout surface maximises movement in its footprint.
- > Double-sided .5mm phenolic coated deck, 3.0" rollers and multi-ply Habasit® belt combine to provide a low maintenance system for thousands of miles.
- > Polyurethane shock absorbers ensure just the right amount of cushioning.



**SPIRIT**



## SPIRIT FITNESS CE800 ELLIPTICAL CROSS TRAINER

- > TV - watch your favourite TV shows right on the console, control the volume, and switch channels by tapping the virtual buttons on the screen
- > Internet - easy to access preselected websites and online apps such as YouTube, Facebook, and Twitter through the internet on the touchscreen
- > Self-Generating, can be placed anywhere in your gym.



**SPIRIT**

## CE900 ENT ELLIPTICAL CROSS TRAINER WITH 10.1" TOUCHSCREEN

- > Long-lasting design with heavy gauge tubular steel with large polyurethane wheels.
- > 21" stride length simulates the natural pedal movement with 2-degree pedal inversion.
- > Electromagnetic resistance system provides 40 levels of increasing intensity.
- > Industrial-grade, 72mm roller bearings for fluid movement.







SPIRIT



### SPIRIT FITNESS CU800 UPRIGHT BIKE

- > A vertical ratcheting, pop pin engaged seat post and micro adjustments of the seat in the fore/aft direction
- > Heart Rate % Profile - There is a bar graph integrated into the console that lets you know where your heart rate is in relation to projected maximum (calculated when you enter your age in the programming section of each program)
- > A heavy-duty 30 lb. flywheel results in more inertia (Revolutions Per Minute & Watt output)



### SPIRIT FITNESS CU900 UPRIGHT BIKE

- > Oversized 1" crank axle along with heavy-duty roller bearings provide long life and reliability.
- > Quick adjust seat easily slides to accommodate users of various heights.
- > Easy in and out ratcheting pedals with 2-degree pedal inversion for a comfortable workout.



**SPIRIT**

### CU900ENT UPRIGHT BIKE WITH 10.1" TOUCHSCREEN

- > Extra wide, 8 groove poly-v belt, spring loaded idler for reduced belt tension for longer belt and bearing life
- > Quick adjust seat easily slides to accommodate users of various heights
- > Oversized 1" crank axle along with heavy-duty roller bearings for reliable longevity
- > Easy in and out ratcheting pedals with 2-degree pedal inversion for a comfortable workout
- > 40 levels of resistance will keep your clients engaged during their entire workout





### SPIRIT FITNESS CR800 RECUMBENT BIKE

- > Easy to adjust the seat by pulling up on the yellow spring loaded handle
- > The seat and backrest are made of high durometer foam pads; the pedals are also padded for less impact stress
- > Heart rate monitor and programs
- > A heavy-duty 14kg flywheel results in more inertia (Revolutions Per Minute & Watt output)



### SPIRIT FITNESS CR900 RECUMBENT BIKE

- > Step-through design allows users to easily enter the moulded foam seat.
- > Seat adjusts to accommodate users of varying heights.
- > Electromagnetic resistance system provides power and 40 levels of increasing intensity.
- > Ratcheting pedals feature 2-degree inversion for comfortable foot placement.



### CR800ENT RECUMBENT BIKE WITH 10.1" TOUCHSCREEN

- > Watch your favourite TV shows right on the console, control the volume, and switch channels by tapping the virtual buttons on the screen
- > Easy to access preselected websites and online apps such as YouTube, Facebook, and Twitter through the internet on the touchscreen
- > 10.1" Touchscreen Display, TV Tuner w/Coaxial or HDMI Input, Wi-Fi 802.11 b/g/n or Ethernet, 3.5mm Headphone Jack, Bluetooth 4.0, USB Service Port
- > The seat and backrest are made of high durometer foam pads; the pedals are also padded for less stress on your feet
- > Large range of programmes to keep you motivated as you train



### CR900ENT RECUMBENT BIKE WITH 10.1" TOUCHSCREEN

- > Extra wide, 8 groove poly-v belt, spring loaded idler for reduced belt tension for longer belt and bearing life
- > Step-through design with easy infinite seat adjustments provides a comfortable workout
- > Oversized 1" crank axle along with heavy-duty roller bearings for reliable longevity
- > easy in and out ratcheting pedals with 2-degree pedal inversion for a comfortable workout
- > 40 levels of resistance will keep your clients engaged during their entire workout







CARDIO



## SPIRIT FITNESS CS800 STEPPER

- > Easy to use 16-inch maximum step up
- > 20 levels of resistance
- > A turbo cooling fan to keep you cool
- > Bright LED screen displays all pertinent information during the workout and a summary of accumulated data scrolls when you have finished
- > Large cushioned pedals



**SPIRIT**

## CRS800 RECUMBENT STEPPER

- > Self-adjusting linear step range from 1 to 12.5 inches and a seat with recline and fore/aft adjustment
- > High Density foam seat pads and cushioned multi-grip handles
- > Seat swivels in 360-degrees making it easy to enter/exit the machine
- > 7.5" Blue Backlit LCD, Heart Rate % Profile, Muscle Activation Profile, Integrated Reading Rack
- > 20 Levels, Watt Range from 5 to 750
- > Oversized Cushioned Foot Pedals



CONTACT OUR SALES TEAM ON [SALES@PRIMALSTRENGTH.COM](mailto:SALES@PRIMALSTRENGTH.COM) 📞 0800 689 4021 (OPTION 2) [PRIMALSTRENGTH.COM](http://PRIMALSTRENGTH.COM)



**wattbike**

## PRO/ TRAINER INDOOR BIKE

- > Engineered to enhance the performance of any athlete
- > Power range: 0-2000W (Wattbike Trainer), 0-3760W (Wattbike Pro)
- > 2.5mm thick zinc shield primed steel frame
- > Transportation rollers fitted
- > Racing seat fitted as standard. Comfort seat available in box, giving you the option of using either seat



CARDIO



**StairMaster**

## GAUNTLET 8 SERIES LCD

- > Includes the Landmark Challenge Program as well as standard console programs. Spartan programs are available on 10" and 15" embedded screens
- > The Landmark Challenge program allows users to climb well-known landmarks from around the world like the Eiffel Tower, the Statue of Liberty and the Taj Mahal. Standard console programs are also included
- > Electronically controlled alternator, brake and drive chain precisely control the stair speed, allowing a wide range of users to exercise smoothly within their comfort zones



CONTACT OUR SALES TEAM ON [SALES@PRIMALSTRENGTH.COM](mailto:SALES@PRIMALSTRENGTH.COM) ☎ 0800 689 4021 (OPTION 2) [PRIMALSTRENGTH.COM](http://PRIMALSTRENGTH.COM)







## IC6 INDOOR CYCLE, POWERED BY ICG

- > The WattRate TFT computer features performance indication in watts, data exchange with external devices, as well as a Coach By Color® intensity guide for both the user and instructor.
- > SELF-POWERED GENERATOR: No batteries required. The IC6 indoor cycle has a compact generator at the flywheel that captures energy provided by the user to recharge an integrated lithium polymer battery.
- > WATTRATE® POWER METER: The IC6 indoor cycle's WattRate® Power Meter displays a precise measurement of the user's effort in watts. This precision is achieved by a positioning sensor that measures the resistance applied to the magnetic brake system.
- > WATTRATE® TFT COMPUTER 2.0: A bright, self-powered, integrated TFT screen and a front LED. This patented feature displays training intensity for both the exerciser on the IC6 and the trainer running the class. Connects training data to external devices via Bluetooth and ANT+.



- > Life Fitness presents its top-of-the-line indoor cycles powered by ICG®: IC4, IC5, IC6 and the award winning IC7. This fleet combines unique design with an enhanced tech experience. Making the Indoor Cycling experience unlike any other, the Coach By Color® intensity guide, WattRate® Power Meter and connectivity to external devices provide encouragement and engagement.

CARDIO



## IC2 INDOOR CYCLE, POWERED BY ICG

- > ICG's entry-level cycle, the IC2 offers a simplified feature-set without compromise on premium grade materials, proven engineering process and styling.
- > POLY-V BELT DRIVETRAIN: Belt requires limited maintenance, improves pedaling technique, permits less momentum-based recovery, makes the rider work efficiently and operates quietly.
- > DUAL-SIDED SPD COMPATIBLE PEDALS: Riders can choose to exercise while wearing cycling shoes with SPD cleats or gym shoes.



## IC3 INDOOR CYCLE, POWERED BY ICG

- > Incredible ride, incredible value. The ergonomic handlebar, advanced geometry and 155mm Q-Factor combine for extreme comfort.
- > 155MM Q FACTOR: Q Factor, the distance between an exerciser's feet when they sit on the bike and pedal, of 155mm makes riding on the IC3 indoor cycle comfortable and feel more like a real road bike. The result is added comfort and pedal stroke efficiency.



## IC4 INDOOR CYCLE, POWERED BY ICG

- > The IC4 combines inviting modern design with high-grade mechanical components, making it the best premium bike in its class.
- > MAGNETIC RESISTANCE LEVER: Service-free technology provides a substantial resistance range. Vertical lever provides tactile feedback and allows for quick adjustment. Located beneath the handlebar, the lever is easy to reach from all riding positions.



## IC5 INDOOR CYCLE, POWERED BY ICG

- > Bluetooth pairing, ANT+ data streaming, advanced magnetic resistance and an intuitive LCD combine to deliver a powerfully engaging exerciser experience that includes data exchange between devices and the Coach By Color intensity guide.
- > WATTRATE® POWER METER: Displays a precise measurement of the user's effort in watts. This precision is achieved by a positioning sensor that measures the resistance applied to the magnetic brake system.

# FREE 3D GYM DESIGN CONSULTATION

We want to partner with you every step of the way to ensure that your facility is the best that it can be. We know that every gym is different so whilst we have some pre-designed, off the shelf packages as suggestions, we prefer to talk to you and learn about what you want from your space. This is your dream, we want to help you to make it a reality. After we have gained an understanding of your vision, we begin to make your project a reality using our specialist design software to create a 3D design of your gym.

Our full 3D gym design service allows you to visualise your gym, work out the best use of space to ensure that you have the best equipment to suit your customers' needs and we can add in your colours, logos and branding so that you can see the finished concept.

Your final gym plans are an excellent tool to help you market the gym prior to opening. We will also use our social media to ensure that when you are ready to launch, your gym has as much exposure as possible.

Our team have first-hand experience in owning gyms,

brand design, facility design, build and equipment development. We work, live and breathe this industry and our aim is to stay on top of the exciting new trends that we see popping up all over the world. Working with Primal Strength, you can be confident that we will be able to provide you with the best solution for your fitness needs.

**SIMPLY GIVE US A CALL ON 0800 689 4021**

**and we will arrange a meeting with you at your new facility or send us the plans and talk us through your ideas. We can help ensure that you have considered every aspect of the gym from the equipment, changing areas, to flooring and lighting. In an ever-expanding industry, it pays to be different, we can help you find your unique selling point.**



## WHAT'S INCLUDED

### SPECIALIST 3D GYM DESIGN

Our team has over 15 years of experience in the fitness industry and is here to help you with your gym layout, 3d design, and visualising it all in the form of video walkthroughs. Our gym design service allows you to plan your gym and work out the best use of space and ensure that you have the best equipment to suit your customers' needs.

### PREMIUM GYM EQUIPMENT

Primal Strength is a British-designed, premium strength, functional and cardio equipment brand. We engineer our equipment to the highest standards in durability, ergonomics and aesthetics. We also partner with some of the industry leaders in cardio equipment: Concept 2, Spirit Fitness, Water Rower, StairMaster and Keiser.

### FULL TURN-KEY SOLUTION

With our strong cardio and gym flooring partnerships and a World-wide distribution network, you can expect support from initial idea to installation and beyond. Our engineers are also on hand should you need any assistance with your equipment.

### FINANCE SOLUTIONS TO ACCOMMODATE ANY FACILITY

You can speak to the team at Primal Strength and we will recommend leasing companies that can offer finance solutions to suit your facility. We work alongside some of the industry leaders, who offer low cost leasing options to both established companies and start-ups.



# CASE STUDIES



## CELTIC FOOTBALL CLUB

We felt that Primal Strength offered a quality of product that was unmatched for us and it's utilised in the 1st team, development and academy squad set ups.

Our goal is to develop players within the club and that fits in with the philosophy in the academy and as the club as a whole, and we feel that Primal Strength will play an important role within that, by giving us a variety of products that really allow us to develop our players athletically and put them in the best possible place to be the best.



## THE STUDIO CROSSFIT SHOREDITCH - LONDON

We chose Primal Strength as they have such a professional team and great equipment with a wide range of products and an even wider range coming out in the future.



## MARINA FITNESS - GOSPORT

The reason we bought from Primal Strength is that it was recommended to us by a friend and we loved the look of it when we saw the pictures and tried it at Bodypower. Plus Steve was so helpful with all of my in depth questions about gyms and equipment.



## GRAFT HÄUS GYM - LEEDS

Primal Strength was an easy choice for us. Having tested a few pieces of the kit at BodyPower it was clear that the range was well thought out and built to last, then following a price comparison with other brands, we were amazed by the value. With all the pieces we were after in a gym, Primal really stood out.



## ORAGYMS - HUDDERSFIELD

As a new start up business I needed to find a full turn key solution and a company that could come in and help me realise my vision. From design and planning to finance, fit-out and aftercare, Primal were our chosen brand after searching through a handful of other more established brands, because I built a relationship with Steven and I felt that the equipment was also more in keeping with our brand.



## FITNESS YEOVIL

We were liaising with a well-known fitness brand regards the gym design and equipment fit-out, but found the service 'sluggish' at best, and the equipment prices were sky-high. We were very dependant at the general attitude of the supplier we were going to use, and then someone suggested we spoke to Primal Strength.



## RENEGADE FITNESS & PERFORMANCE - STIRLING

We were fortunate enough to have the opportunity to expand Renegade in 2017. With a brand new city centre location looming, in a unique building we were keen to optimise the space and create a gym where people could train in any style they wished.

VIEW ALL OUR CASE STUDIES AT [PRIMALSTRENGTH.COM/CASE-STUDIES](https://primalstrength.com/case-studies)

# GLOBALLY TRUSTED BRAND

Primal Strength work with many blue chip companies from large corporations to small independant personal training studios. We work worldwide from Europe to the Middle East.

Here are just a few of our clients... and it continues to grow!





# PRODUCT LIST

## RACKS

Monster Series Commercial Performance Rack	3
Adjustable Monolift	3
Monster Series Commercial Performance Rack with 50mm Platform	4
Commercial Dip Attachment	4
Commercial Monster Rack System	5
Leg Press Attachment for Elite Power Rack/Smith Machine /Functional Trainer System	5
Commercial Power Rack / Smith Machine / Functional Trainer Monster System	6
Commercial V2 FID Bench with Chrome Supports	6
Leg Press Attachment for Elite Power Rack/Smith Machine /Functional Trainer System	6
GLS Jammer Arms	7
Jammer Arms For Monster Rack Systems	7
Jammer Arms for Half & Power Racks	7
Performance Safety Rack	8
Commercial Full Power Rack	8
V2 HD Power Rack	8
V2.0 Commercial Smith Machine	8
Yoke Rack	9
Light Commercial Squat Rack	9
Foldable Commercial Power Rack	9
Wall Mounted Foldable Rack	9
V2.0 Commercial Half Rack Matte Black	10
V2.0 Commercial Half Rack Verde Ithaca	10
V2.0 Commercial Half Rack Matte Grey	10
V2.0 Commercial Half Rack Hot Pink	10
V2.0 Commercial Half Rack Blue	10
V2.0 Commercial Half Rack Yellow	10
V2.0 Commercial Half Rack Red	10
Primal Strength Performance Wall	11
PT POD	11
Central Storage	11
Monster Hybrid Rig	12
Group PT Rig 1	13
Group PT Rig 2	13
Group PT Rig 3	13
Monster Spyder Rig	14

## PLATE LOADED MACHINES

Commercial ISO Incline Leg Press	16
Commercial ISO Linear 45 Degree Leg Press	16
Commercial ISO Hack/V Squat	16
Commercial ISO Leverage Squat	17
Commercial ISO V2 Belt Squat machine	17
Commercial ISO Seated Calf Machine	17
Commercial ISO Standing Hamstring Curl	18

Commercial ISO Pendulum Squat	18
Commercial ISO Glute Drive	18
Commercial ISO Nordic Curl	19
Commercial ISO Leg Extension	19
Commercial ISO Glute Kick Back	19
Commercial ISO Lat Pull Down	20
Commercial ISO Full Back Row	20
Commercial ISO Incline T-Bar Back Row	20
Commercial ISO Low Back Row	21
Commercial ISO Cambered Bicep Curl	21
Commercial ISO Incline T-Bar Back Row	21
Commercial ISO Chest Press	22
Commercial ISO Tricep Dip	23
Commercial ISO Incline Chest Press	23
Commercial ISO Horizontal Chest Press	23
Commercial ISO Shoulder Press	24

## SINGLE/MULTI STATION MACHINES

Monster Series 125kg Lat Pull Down	26
Monster Series 75kg Standing Lat Raise	26
Monster Series 100kg Supported Chin-Dip	26
Monster Series 125kg Leg Extension	27
Monster Series 100kg Prone Hamstring Curl	27
Monster Series 100kg Abductor/Adductor	27
Monster Series 125kg Chest Press	28
Monster Series 100kg Pec Dec & Rear Fly	28
Monster Series 100kg Shoulder Press	28
Monster Series 100kg Arm Curl	28
Commercial 4 Stack Multi Station	29
Commercial 5 Stack Multi Station	29
Functional Trainer Dual Adjustable Pulley	30
Dual Abductor/Adductor 90kg stack	30
Commercial Dual Arm Cable Pulley	30
Commercial Leg Extension 125kg Stack	31
Dual Leg Extension / Leg Curl Selectorised Machine	32
Dual Abductor/Adductor 90kg stack	32
Leg Press Selectorised Machine	32
Commercial Olympic Smith Machine	33
Dual Chest / Shoulder Press Selectorised Machine	34
Dual Lat Pulldown / Seated Row Selectorised Machine	34
Dual Pec Fly / Rear Delt Selectorised Machine	34
Dual Assisted Chin / Dip Selectorised Machine	35
Low Row Selectorised Machine	35
Cable Side Lateral Raise Machine 100kg Stack	35
Commercial Lat Pull Down 125kg Stack	36
Commercial Cable Crossover 2 x 100kg stack	36

## PLATFORMS

Integrated Olympic Lifting Platform for Stealth Half Rack / Full Rack	38
Olympic Lifting Platform with Steel Frame and Band Hooks	38
Custom Platform Inserts	39

## BENCHES

V2 FID Bench with Chrome Supports	41
Commercial Fitness Elite FID Bench. Adjustable Flat/Incline/Decline	41
Multi Adjustable Bench with Foot Support	41
Stealth Commercial Flat Box Bench	42
Stealth Commercial Fitness Elite Flat Dumbbell Bench	42
Stealth Commercial Flat and Incline Box Bench	42
Monster Series Commercial Flat Dumbbell Bench	42
Custom Bench Wraps	43
Commercial Fitness Adjustable Olympic Bench With Spotter & Platform	44
Commercial GHD Multi Adjustable with Band Hooks	45
Light Commercial Sissy Squat	45
Monster Series Hip Thrust Floor GHD	45
Commercial Sissy Squat	45
Hip Thruster Bench & Floor GHD	46
Commercial Hyper Extension/Roman Chair	46
Dual Commercial Preacher Curl	46
Light Commercial Preacher Curl Bench	46
Commercial Olympic Safety Bench	47
Commercial Incline Olympic Gym Bench	47
Commercial Olympic Decline Gym Bench	47
Commercial Combo IPF Bench	47

## OLYMPIC BARS & COLLARS

Primal Safety Squat Bar Black	49
Primal Safety Squat Bar Pink	49
230cm Olympic Deadlift Bar	49
Commercial Multi Grip Olympic Shrug Bar Matte Nero	49
Russian 28mm Olympic Bar & Collars	49
Open Hex Trap Bar	49
"It's Heavy" Dual Olympic 8 Needle Bar	50
"Linda" Pink Olympic 15kg Bar	50
Ladies "Linda" Olympic 25mm 15kg Technique Bar	50
Primal Strength Austin Texas Power Bar	51
Primal Strength 7ft Black Olympic bar	51
Olympic 7ft Matte Nero Bar, 4 Needle Bush Bearings	51
230cm Olympic Deadlift Bar	51
7.5kg Aluminium Technique Bar	51
Hip Thrust Bar	52
Aluminium Lockjaw Collar	53

## OLYMPIC DISCS & OLYMPIC BUMPER PLATES

Commercial Olympic Fitness Lock Style Collars	53
Premium Rubber Olympic Disc with Stainless Steel Ring	55
Urethane Olympic Discs	55
Steel Calibrated Plates	56
Competition Colour Bumpers	56
Olympic Coloured Bumper Plates	58
Set Of Precision Chrome Micro/Change Plates	59
Hi-Temp Fleck Grain Bumper Plates	59
Elite PU Competition Bumper Plates	59
Urethane Dumbbell Set 2-10kg (10 Pairs)	61
Urethane Dumbbell Set 2.5-25kg (10 pairs)	61
Urethane Dumbbell Set 27.5-50kg (10 Pairs)	61
Urethane Dumbbell Set 52.5-70kg (8 Pairs)	61

## PREMIUM FIXED DUMBBELLS & BARBELLS

Premium Rubber Nero Stainless Steel Handle Dumbbells	62
Commercial Premium Rubber/Stainless Steel 27.5kg-50kg Dumbbell Set (10 Pairs)	62
Commercial Premium Rubber/Stainless Steel 2.5kg-25kg Dumbbell Set (10 Pairs)	62
Premium Rubber Nero EZ Barbell Set 10-45kg 10 Pair Set	63
Premium Rubber Nero Barbell Set 10-45kg 10 Pair Set Straight Bar Rubber Hex Dumbbells	63
Custom Steel Dumbbell Set 4-40kg (2kg increments 35mm handle) 20 pairs 2 sets of 10 kg pairs	64
Custom Steel Dumbbell Set (3-25kg)	64
Custom Steel Dumbbell Set 3-50kg (2.5kg increments 20 pairs )	64
Commercial 10 Pair Dumbbell Rack	65
Premium Barbell Rack	65
10 Pair Commercial Upright Dumbbell Rack Matte Nero	65
10 Pair Commercial Horizontal Hex Dumbbell Rack Matte Nero	65
3 Tier Dumbbell Rack	65

## FUNCTIONAL ACCESSORIES

Olympic Chains 30kg Pair	67
Mini Bands	67
Powerbands	67
Material Glute Bands	67
Premium Cast Kettlebells	69
Commercial Kettlebell Rack	69
Fitness Ladders	70
Fitness Hurdles	70
Fitness Foam Roller	70
Camouflage Foam Roller	70
3-in-1 Foam Roller Set	70

# PRODUCT LIST

Anti-Burst Tyre Slam Balls	71
Camouflage Sandbags	72
Commercial Sandbag Stand	72
Fitness Ab Sling	73
Nero Gym Rings	73
Commercial Canvas Battle Rope	73
38mm x 10m Battle Rope with Nylon Cover	73
Parallette	73
Ab Mat	73
Commercial PU Covered Wooden Plyo Box	74
Wooden Plyo Box	75
Foam Plyo Box Set	75
Commercial PU Covered Wooden Plyo Box	75
GLS Doublebells	76
Commercial Doublebell Stand	76
Commercial 20kg Camouflage Weighted vest	77
Steel Speed Rope	77
Wall Ball Digital Camouflage	77
Commercial Premium Prowler	78
Commercial Premium Prowler Sled	79
Fitness Harness	79
Prowler Dog Sled with Harness	79
Double Handle Medicine Balls	80
Commercial Medicine Ball Stand	80
Squat Ramps	81
Commercial Farmer Walk Handles	81
Full Deadlift Bar Jack	81
Commercial Jerk Blocks	81

## FITNESS MAD ACCESSORIES

Fitness Mad Studio Pro 500kg Swiss Ball & Pump	82
Fitness Mad Club Aerobic Mat Eyelets 9.5mm	82
Fitness Mad Exercise Mat Rack	82
Fitness Mad Studio Pro Rebounder 40"	83
Fitness Mad Aerobic Step	83
Fitness Mad Pro Suspension Trainer	83
Fitness Mad Neoprene Dumbbells 0.5kg - 5kg	83
Fitness Mad Neoprene Dumbbell Rack	83

## CABLE AND BARBELL ATTACHMENTS

Black Revolving Double Handle Attachment	85
Black Lat Pull Down Bar	85
Black Revolving V Bar	85
Revolving Single Tricep Handle	85
Double Tricep Rope	85
Black Revolving Straight Bar	85

Double Handle Lat Bar	86
Max Grip Handles	86
Black Curl Bar Attachment	86
GLS Crane Handle	87
War Hammer 360	88
Stand Alone Landmine	88
Wishbone	88

## STORAGE SOLUTIONS

Olympic Disc & Barbell Rack	90
Premium Barbell Rack	90
Commercial Horizontal Olympic Bar and Bumper holder	90
9pc Barbell Rack	91
Bumper Plate Trolley	91
Free Standing Wall Storage	91
Bumper Plate Rack with Wheels	91
8pc Medline Ball Rack	92
8pc Wall Mounted Barbell Rack	92
Commercial Sandbag Stand	92
Central Storage	92

## FLOORING AND ASTRO TRACKS

Commercial EPDM Premium Gym Tiles	94
Commercial Grade Gym Floor Matting	95
Premium Astro Track	96
Custom Astro Track	97

## CV EQUIPMENT

Curved Treadmill	100
Incline Trainer Hiitmill	101
Dual Drive HIIT Airbike	101
Commercial Grappler	101
Keiser M3i Lite Indoor Bike	102
Concept2 SkiErg with Stand	103
Concept2 Model D PMS	104
Concept2 Model E PMS	104
Concept2 BikeErg	104
WaterRower Club Rowing Machine with S4 Performance Monitor	105
WaterRower M1 HiRise Rowing Machine with S4 Performance Monitor	105
WaterRower M1 LoRise Rowing Machine with S4 Performance Monitor	105
Spirit Fitness CT800 Treadmill	106
Spirit Fitness CT850 Treadmill	106
Spirit Fitness CT900 Treadmill	106
Spirit Fitness CT950 ENT Treadmill with 15.6" Touchscreen	107
Spirit Fitness CE800 Elliptical Cross Trainer	108
Spirit Fitness CE900 ENT Elliptical Cross Trainer with 10.1" Touchscreen	109

Spirit Fitness CU800 Upright Bike	110
Spirit Fitness CU900 Upright Bike	110
Spirit Fitness CU900 ENT Upright Bike with 10.1" Touchscreen	111
Spirit Fitness CR800 Recumbent Bike	112
Spirit Fitness CR900 Recumbent Bike	112
Spirit Fitness CR800 ENT Recumbent Bike with 10.1" Touchscreen	113
Spirit Fitness CS800 Stepper	114
Spirit Fitness CRS800 Stepper	115
Wattbike Pro/Trainer Indoor Bike	116
Stairmaster Gauntlet 8 Series LCD	117
Life Fitness IC6 Indoor Cycle	118
Life Fitness IC2 Indoor Cycle	119
Life Fitness IC3 Indoor Cycle	119
Life Fitness IC4 Indoor Cycle	119
Life Fitness IC5 Indoor Cycle	119
3D Gym Design	120
Case Studies	122
Globally Trusted Brand	124



## NOTES



# PRIMAL

STRENGTH

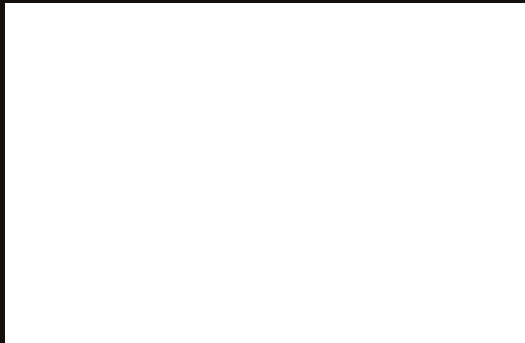

✉ SALES@PRIMALSTRENGTH.COM 📞 0800 689 4021

**PRIMALSTRENGTH.COM**